

ProGator® Utility Vehicle Attachments

TECHNICAL MANUAL

**John Deere
Worldwide Commercial and
Consumer Equipment Division**

TM1803 (03May00)

**TC125 Turf Collection System
TD100 Top Dresser
Cab**

This technical manual is written for an experienced technician and contains sections that are specifically for this product. It is a part of a total product support program.

The manual is organized so that all the information on a particular system is kept together. The order of grouping is as follows:

- Table of Contents
- Specifications
- Component Location
- System Schematic
- Theory of Operation
- Troubleshooting Chart
- Diagnostics
- Tests & Adjustments
- Repair

Note: Depending on the particular section or system being covered, not all of the above groups may be used.

Each section will be identified with a symbol rather than a number. The groups and pages within a section will be consecutively numbered.

We appreciate your input on this manual. To help, there are postage paid post cards included at the back. If you find any errors or want to comment on the layout of the manual please fill out one of the cards and mail it back to us.

All information, illustrations and specifications in this manual are based on the latest information available at the time of publication. The right is reserved to make changes at any time without notice.

COPYRIGHT© 2000
Deere & Co.
John Deere Worldwide Commercial and
Consumer Equipment Division
Horicon, WI
All rights reserved

Safety



Specifications and Information



TC125 Turf Collection System



TD100 Top Dresser



Cab



Miscellaneous

M



RECOGNIZE SAFETY INFORMATION



This is the safety-alert symbol. When you see this symbol on your machine or in this manual, be alert to the potential for personal injury.

Follow recommended precautions and safe servicing practices.

Understand Signal Words

A signal word—DANGER, WARNING, or CAUTION—is used with the safety-alert symbol. DANGER identifies the most serious hazards.

DANGER or WARNING safety signs are located near specific hazards. General precautions are listed on CAUTION safety signs. CAUTION also calls attention to safety messages in this manual.

REPLACE SAFETY SIGNS

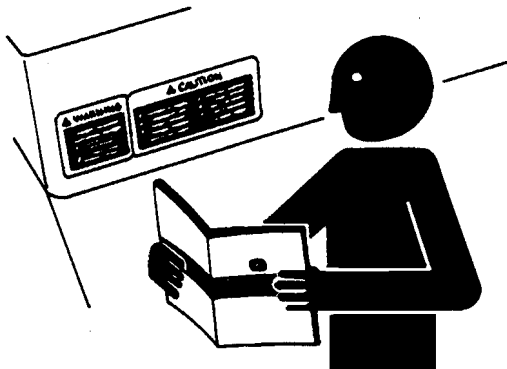

TS201

Replace missing or damaged safety signs. See the machine operator's manual for correct safety sign placement.

HANDLE FLUIDS SAFELY-AVOID FIRES

Be Prepared For Emergencies



TS227

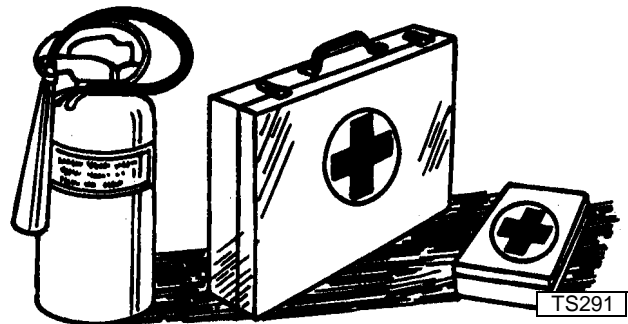

TS291

When you work around fuel, do not smoke or work near heaters or other fire hazards.

Store flammable fluids away from fire hazards. Do not incinerate or puncture pressurized containers.

Make sure machine is clean of trash, grease, and debris.

Do not store oily rags; they can ignite and burn spontaneously.

Be prepared if a fire starts.

Keep a first aid kit and fire extinguisher handy.

Keep emergency numbers for doctors, ambulance service, hospital, and fire department near your telephone.

USE CARE AROUND HIGH-PRESSURE FLUID LINES

Avoid High-pressure Fluids

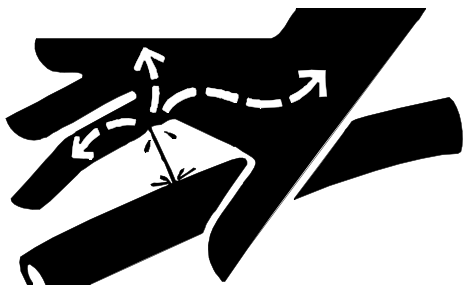

Escaping fluid under pressure can penetrate the skin causing serious injury.

Avoid injury from escaping fluid under pressure by stopping the engine and relieving pressure in the system before disconnecting or connecting hydraulic or other lines. Tighten all connections before applying pressure.

Search for leaks with a piece of cardboard. Protect hands and body from high pressure fluids.

If an accident occurs, see a doctor immediately. Any fluid injected into the skin must be surgically removed within a few hours or gangrene may result. Doctors unfamiliar with this type of injury should reference a knowledgeable medical source. Such information is available from Deere & Company Medical Department in Moline, Illinois, U.S.A.

Avoid Heating Near Pressurized Fluid Lines



TS953

Flammable spray can be generated by heating near pressurized fluid lines, resulting in severe burns to yourself and bystanders. Do not heat by welding, soldering, or using a torch near pressurized fluid lines or other flammable materials. Pressurized lines can be accidentally cut when heat goes beyond the immediate flame area.

USE SAFE SERVICE PROCEDURES

Wear Protective Clothing

Wear close fitting clothing and safety equipment appropriate to the job.

Prolonged exposure to loud noise can cause impairment or loss of hearing. Wear a suitable hearing protective device such as earmuffs or earplugs to protect against objectionable or uncomfortable loud noises.

Operating equipment safely requires the full attention of the operator. Do not wear radio or music headphones while operating machine.

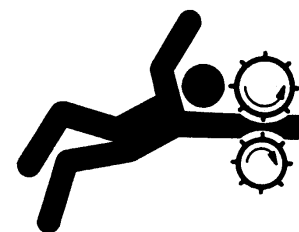
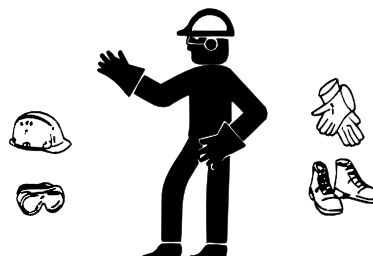

TS228

Service Machines Safely

Tie long hair behind your head. Do not wear a necktie, scarf, loose clothing, or necklace when you work near machine tools or moving parts. If these items were to get caught, severe injury could result.

Remove rings and other jewelry to prevent electrical shorts and entanglement in moving parts.

Use Proper Tools

Use tools appropriate to the work. Makeshift tools and procedures can create safety hazards. Use power tools only to loosen threaded parts and fasteners. For loosening and tightening hardware, use the correct size tools. **DO NOT** use U.S. measurement tools on metric fasteners. Avoid bodily injury caused by slipping wrenches. Use only service parts meeting John Deere specifications.



Park Machine Safely

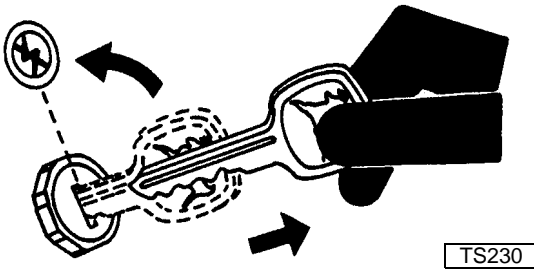

Before working on the machine:

1. Lower all equipment to the ground.
2. Stop the engine and remove the key.
3. Disconnect the battery ground strap.
4. Hang a "DO NOT OPERATE" tag in operator station.

Support Machine Properly And Use Proper Lifting Equipment

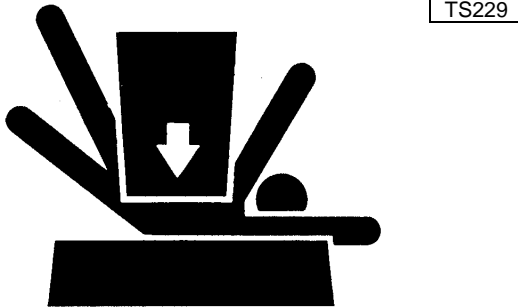

If you must work on a lifted machine or attachment, securely support the machine or attachment.

Do not support the machine on cinder blocks, hollow tiles, or props that may crumble under continuous load. Do not work under a machine that is supported solely by a jack. Follow recommended procedures in this manual.

Lifting heavy components incorrectly can cause severe injury or machine damage. Follow recommended procedure for removal and installation of components in the manual.

Work In Clean Area

Before starting a job:

1. Clean work area and machine.
2. Make sure you have all necessary tools to do your job.
3. Have the right parts on hand.
4. Read all instructions thoroughly; do not attempt shortcuts.

Using High Pressure Washers

Directing pressurized water at electronic/electrical components or connectors, bearings, hydraulic seals, fuel injection pumps or other sensitive parts and components may cause product malfunctions. Reduce pressure and spray at a 45 to 90 degree angle.

Illuminate Work Area Safely

Illuminate your work area adequately but safely. Use a portable safety light for working inside or under the machine. Make sure the bulb is enclosed by a wire cage. The hot filament of an accidentally broken bulb can ignite spilled fuel or oil.

Work In Ventilated Area

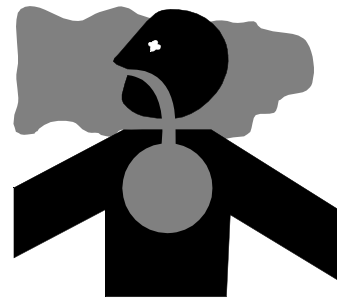

Engine exhaust fumes can cause sickness or death. If it is necessary to run an engine in an enclosed area, remove the exhaust fumes from the area with an exhaust pipe extension.

If you do not have an exhaust pipe extension, open the doors and get outside air into the area.

Remove Paint Before Welding Or Heating

Avoid potentially toxic fumes and dust. Hazardous fumes can be generated when paint is heated by welding, soldering, or using a torch. Do all work outside or in a well ventilated area. Dispose of paint and solvent properly. Remove paint before welding or heating: If you sand or grind paint, avoid breathing the dust. Wear an approved respirator. If you use solvent or paint stripper, remove stripper with soap and water before welding. Remove solvent or paint stripper containers and other flammable material from area. Allow fumes to disperse at least 15 minutes before welding or heating.

AVOID INJURY FROM ROTATING BLADES, AUGERS AND PTO SHAFTS

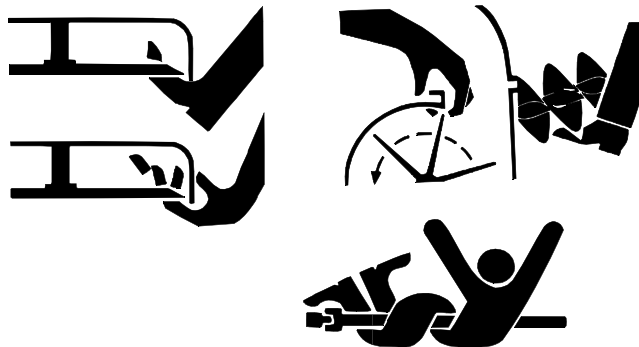

Keep hands and feet away while machine is running. Shut off power to service, lubricate or remove mower blades, augers or PTO shafts.

HANDLE CHEMICAL PRODUCTS SAFELY

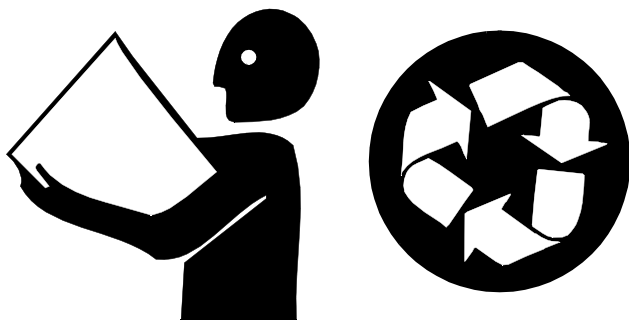

Direct exposure to hazardous chemicals can cause serious injury. Potentially hazardous chemicals used with John Deere equipment include such items as lubricants, coolants, paints, and adhesives.

A Material Safety Data Sheet (MSDS) provides specific details on chemical products: physical and health hazards, safety procedures, and emergency response techniques. Check the MSDS before you start any job using a hazardous chemical. That way you will know exactly what the risks are and how to do the job safely. Then follow procedures and recommended equipment.

Dispose of Waste Properly

Improperly disposing of waste can threaten the environment and ecology. Potentially harmful waste used with John Deere equipment include such items as oil, fuel, coolant, brake fluid, filters, and batteries. Use leakproof containers when draining fluids. Do not use food or beverage containers that may mislead someone into drinking from them. Do not pour waste onto the ground, down a drain, or into any water source. Inquire on the proper way to recycle or dispose of waste from your local environmental or recycling center, or from your John Deere dealer.



LIVE WITH SAFETY



Before returning machine to customer, make sure machine is functioning properly, especially the safety systems. Install all guards and shields.

CONTENTS

	Page
SPECIFICATIONS	3
TC125 MATERIAL COLLECTION SYSTEM SPECIFICATIONS.....	3
TD100 TOP DRESSER.....	3
O-RING SEAL SERVICE RECOMMENDATIONS	4
FACE SEAL FITTINGS WITH INCH STUD ENDS TORQUE	4
FACE SEAL FITTINGS WITH METRIC STUD ENDS TORQUE.....	5
O-RING FACE SEAL FITTINGS	6
O-RING BOSS FITTINGS.....	6
INCH FASTENER TORQUE VALUES	7
METRIC FASTENER TORQUE VALUES	8
LUBRICANTS	9
HYDROSTATIC TRANSMISSION & HYDRAULIC OIL.....	9
ALTERNATIVE LUBRICANTS.....	9
LUBRICANT STORAGE	9
CHASSIS GREASE.....	10



SPECIFICATIONS

TC125 TURF COLLECTION SYSTEM SPECIFICATIONS

Hydraulic Pump

Minimum Working Pressure 13790 kPa (2000 psi) at 22.7 L/min (6 gpm)
 Maximum Working Pressure 15513 kPa (2250 psi) at 37.9 L/min (10 gpm)

Hopper and Rotary Brush

Hopper Capacity 0.7 m³ (25 cu ft)
 Number of Brush Sections 8
 Speed 500 - 600 rpm

TD100 TOP DRESSER SPECIFICATIONS

General

Model TD100
 Height 63.5 cm (25 in.)
 Width 163.8 cm 64.5 in.)
 Length 130.8 cm (51.5 in.)
 Weight (empty) 311 kg (685 lb)
 Weight (shipping) 367 kg (810 lb)
 Volume (load leveled) 0.35 m³ (12 cu ft)
 Volume (load heaped) 0.54 m³ (19 cu ft)
 Brush Diameter 22.9 cm (9 in.)
 Chain Type (drive) #40 O-ring sealed roller chain
 Vehicle Operating Engine Speed 3200 rpm
 Drive Chain Deflection (tension) 3.2 to 6.4 mm (1/8 to 1/4 in.)



O-RING SEAL SERVICE RECOMMENDATIONS

FACE SEAL FITTINGS WITH INCH STUD ENDS TORQUE

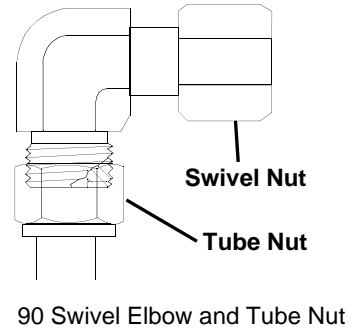
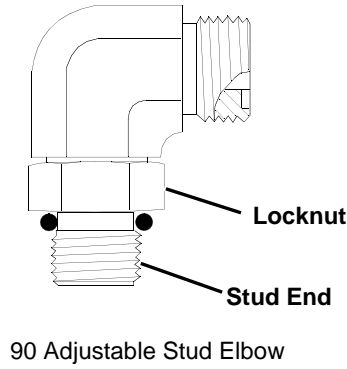
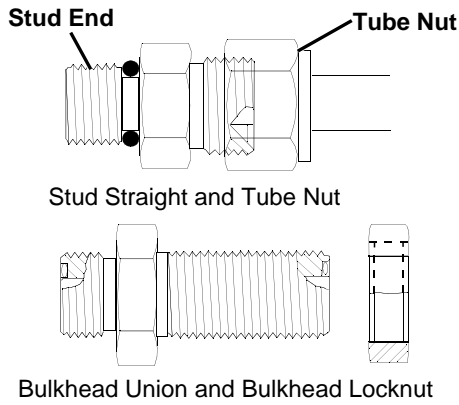

Nominal Tube OD/Hose ID				Face Seal Tube/Hose End					O-ring Stud Ends		
Metric Tube OD	Inch Tube OD			Thread Size	Tube Nut/ Swivel Nut Torque		Bulkhead Locknut Torque		Thread Size	Straight Fitting or Locknut Torque	
	mm	Dash Size	in.		mm	in.	N•m	lb-ft		N•m	lb-ft
	-3	0.188	4.76						3/8-24	8	6
6	-4	0.250	6.35	9/16-18	16	12	12	9	7/16-20	12	9
8	-5	0.312	7.94						1/2-20	16	12
10	-6	0.375	9.52	11/16-16	24	18	24	18	9/16-18	24	18
12	-8	0.500	12.70	13/16-16	50	37	46	34	3/4-16	46	34
16	-10	0.625	15.88	1-14	69	51	62	46	7/8-14	62	46
	-12	0.750	19.05	1-3/16-12	102	75	102	75	1-1/16-12	102	75
22	-14	0.875	22.22	1-3/16-12	102	75	102	75	1-3/16-12	122	90
25	-16	1.000	25.40	1-7/16-12	142	105	142	105	1-5/16-12	142	105
32	-20	1.25	31.75	1-11/16-12	190	140	190	140	1-5/8-12	190	140
38	-24	1.50	38.10	2-12	217	160	217	160	1-7/8-12	217	160

NOTE: Torque tolerance is +15% / -20%.

FACE SEAL FITTINGS WITH METRIC STUD ENDS TORQUE

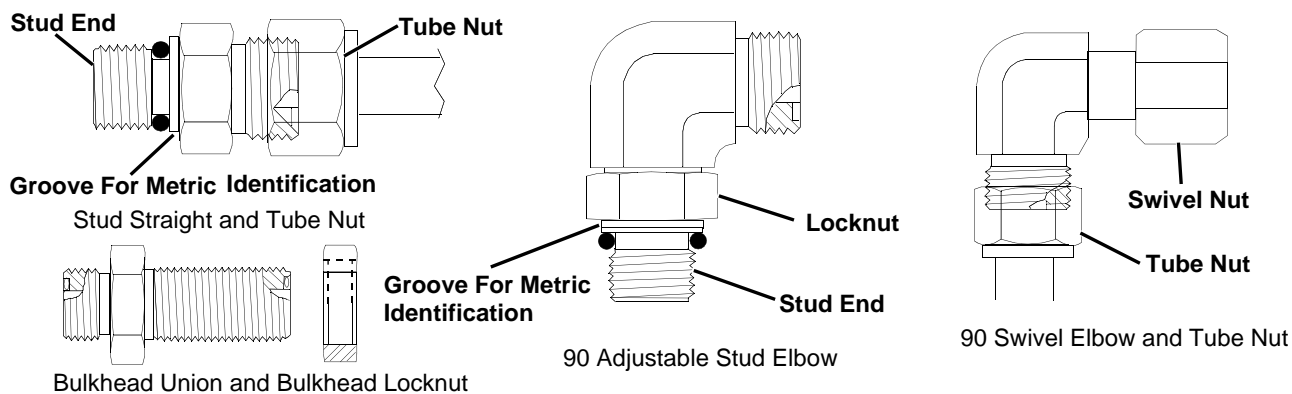

Nominal Tube OD/Hose ID				Face Seal Tube/Hose End						O-ring Stud Ends, Straight Fitting or Locknut					
Metric Tube OD	Inch Tube OD			Thread Size	Hex Size	Tube Nut/ Swivel Nut Torque		Bulkhead Locknut Torque		Thread Size	Hex Size	Steel or Gray Iron Torque		Aluminum Torque	
	mm	Dash Size	in.			mm	in.	mm	N•m			lb-ft	N•m	lb-ft	mm
6	-4	0.250	6.35	9/16-18	17	16	12	12	9	M12X1.5	17	21	15.5	9	6.6
8	-5	0.312	7.94							M14X1.5	19	33	24	15	11
10	-6	0.375	9.52	11/16-16	22	24	18	24	18	M16X1.5	22	41	30	18	13
12	-8	0.500	12.70	13/16-16	24	50	37	46	34	M18X1.5	24	50	37	21	15
16	-10	0.625	15.88	1-14	30	69	51	62	46	M22X1.5	27	69	51	28	21
	-12	0.750	19.05	1-3/16-12	36	102	75	102	75	M27X2	32	102	75	46	34
22	-14	0.875	22.22	1-3/16-12	36	102	75	102	75	M30X2	36				
25	-16	1.000	25.40	1-7/16-12	41	142	105	142	105	M33X2	41	158	116	71	52
28										M38X2	46	176	130	79	58
32	-20	1.25	31.75	1-11/16-12	50	190	140	190	140	M42X2	50	190	140	85	63
38	-24	1.50	38.10	2-12	60	217	160	217	160	M48X2	55	217	160	98	72

NOTE: Torque tolerance is +15% / -20%.

O-RING FACE SEAL FITTINGS

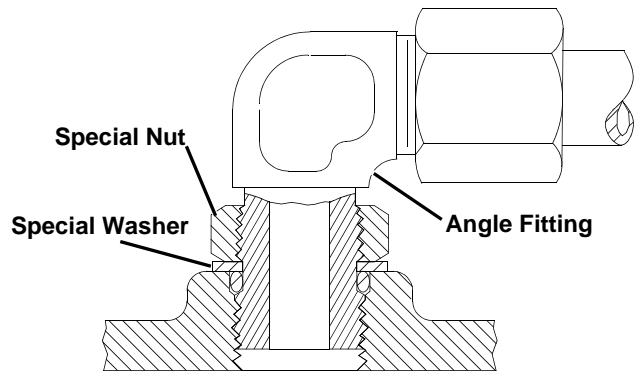
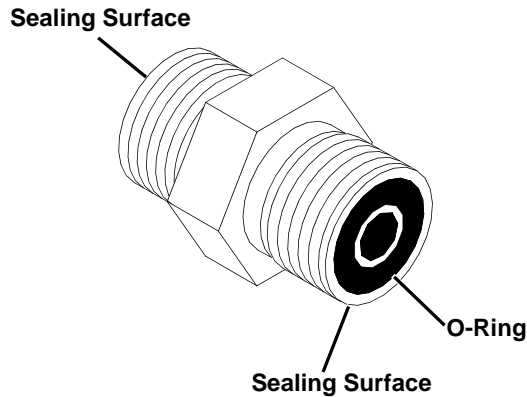

1. Inspect the fitting sealing surfaces. They must be free of dirt or defects.
2. Inspect the O-ring. It must be free of damage or defects.
3. Lubricate O-rings and install into groove using petroleum jelly to hold in place.
4. Push O-ring into the groove with plenty of petroleum jelly so O-ring is not displaced during assembly.
5. Index angle fittings and tighten by hand pressing joint together to insure O-ring remains in place.
6. Tighten fitting or nut to torque value shown on the chart per dash size stamped on the fitting. Do not allow hoses to twist when tightening fittings.

3. For angle fittings, loosen special nut and push special washer against threads so O-ring can be installed into the groove of fitting.
4. Turn fitting into the boss by hand until special washer or washer face (straight fitting) contacts boss face and O-ring is squeezed into its seat.
5. To position angle fittings, turn the fitting counter-clockwise a maximum of one turn.
6. Tighten straight fittings to torque value shown on chart. For angle fittings, tighten the special nut to value shown in the chart while holding body of fitting with a wrench.

O-RING BOSS FITTINGS

1. Inspect boss O-ring boss seat. It must be free of dirt and defects. If repeated leaks occur, inspect for defects with a magnifying glass. Some raised defects can be removed with a slip stone.

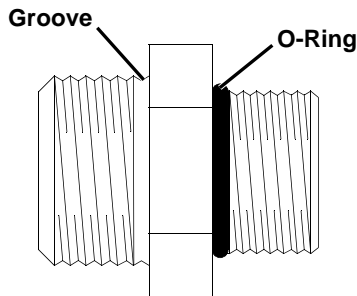

2. Put hydraulic oil or petroleum jelly on the O-ring. Place electrical tape over the threads to protect O-ring from nicks. Slide O-ring over the tape and into the groove of fitting. Remove tape.

STRAIGHT FITTING OR SPECIAL NUT TORQUE







Thread Size	Torque ^a		Number of Flats ^b
	N•m	lb-ft	
3/8-24 UNF	8	(6)	2
7/16-20 UNF	12	(9)	2
1/2-20 UNF	16	(12)	2
9/16-18 UNF	24	(18)	2
3/4-16 UNF	46	(34)	2
7/8-14 UNF	62	(46)	1-1/2
1-1/16-12 UN	102	(75)	1
1-3/16-12 UN	122	(90)	1
1-5/16-12 UN	142	(105)	3/4
1-5/8-12 UN	190	(140)	3/4
1-7/8-12 UN	217	(160)	1/2

a. Torque tolerance is ± 10 percent.

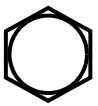
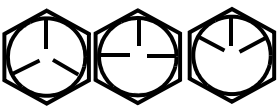
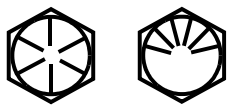
b. To be used if a torque wrench cannot be used. After tightening fitting by hand, put a mark on nut or boss; then tighten special nut or straight fitting the number of flats shown.

INCH FASTENER TORQUE VALUES



SAE Grade and Head Markings	1 or 2 ^b No Marks 	5 5.1 5.2 	8 8.2 
SAE Grade and Nut Markings	2 No Marks 	5  	8   TS1162

SIZE	Grade 1		Grade 2 ^b				Grade 5, 5.1 or 5.2				Grade 8 or 8.2					
	Lubricated ^a		Dry ^a		Lubricated ^a		Dry ^a		Lubricated ^a		Dry ^a		Lubricated ^a		Dry ^a	
	N•m	lb-ft	N•m	lb-ft	N•m	lb-ft	N•m	lb-ft	N•m	lb-ft	N•m	lb-ft	N•m	lb-ft	N•m	lb-ft
1/4	3.7	2.8	4.7	3.5	6	4.5	7.5	5.5	9.5	7	12	9	13.5	10	17	12.5
5/16	7.7	5.5	10	7	12	9	15	11	20	15	25	18	28	21	35	26
3/8	14	10	17	13	22	16	27	20	35	26	44	33	50	36	63	46
7/16	22	16	28	20	35	26	44	32	55	41	70	52	80	58	100	75
1/2	33	25	42	31	53	39	67	50	85	63	110	80	120	90	150	115
9/16	48	36	60	45	75	56	95	70	125	90	155	115	175	130	225	160
5/8	67	50	85	62	105	78	135	100	170	125	215	160	215	160	300	225
3/4	120	87	150	110	190	140	240	175	300	225	375	280	425	310	550	400
7/8	190	140	240	175	190	140	240	175	490	360	625	450	700	500	875	650
1	290	210	360	270	290	210	360	270	725	540	925	675	1050	750	1300	975
1-1/8	470	300	510	375	470	300	510	375	900	675	1150	850	1450	1075	1850	1350
1-1/4	570	425	725	530	570	425	725	530	1300	950	1650	1200	2050	1500	2600	1950
1-3/8	750	550	950	700	750	550	950	700	1700	1250	2150	1550	2700	2000	3400	2550
1-1/2	1000	725	1250	925	990	725	1250	930	2250	1650	2850	2100	3600	2650	4550	3350

DO NOT use these hand torque values if a different torque value or tightening procedure is given for a specific application. Torque values listed are for general use only and include a ±10% variance factor. Check tightness of fasteners periodically. DO NOT use air powered wrenches.

Shear bolts are designed to fail under predetermined loads. Always replace shear bolts with identical grade.

Fasteners should be replaced with the same grade. Make sure fastener threads are clean and that you properly start thread engagement. This will prevent them from failing when tightening.

When bolt and nut combination fasteners are used, torque values should be applied to the **NUT** instead of the bolt head.

Tighten toothed or serrated-type lock nuts to the full torque value.

^a "Lubricated" means coated with a lubricant such as engine oil, or fasteners with phosphate and oil coatings. "Dry" means plain or zinc plated (yellow dichromate - Specification JDS117) without any lubrication.

^b "Grade 2" applies for hex cap screws (not hex bolts) up to 152 mm (6-in.) long. "Grade 1" applies for hex cap screws over 152 mm (6-in.) long, and for all other types of bolts and screws of any length.

Reference: JDS—G200.

METRIC FASTENER TORQUE VALUES

Property Class and Head Markings	4.8	8.8	9.8	10.9	12.9
Property Class and Nut Markings	5	10	10	12	

TS1163

SIZE	Class 4.8				Class 8.8 or 9.8				Class 10.9				Class 12.9			
	Lubricated ^a		Dry ^a		Lubricated ^a		Dry ^a		Lubricated ^a		Dry ^a		Lubricated ^a		Dry ^a	
	N•m	lb-ft	N•m	lb-ft	N•m	lb-ft	N•m	lb-ft	N•m	lb-ft	N•m	lb-ft	N•m	lb-ft	N•m	lb-ft
M6	48	3.5	6	4.5	9	6.5	11	8.5	13	9.5	17	12	15	11.5	19	14.5
M8	12	8.5	15	11	22	16	28	20	32	24	40	30	37	28	47	35
M10	23	17	29	21	43	32	55	40	63	47	80	60	75	55	95	70
M12	40	29	50	37	75	55	95	70	110	80	140	105	130	95	165	120
M14	63	47	80	60	120	88	150	110	175	130	225	165	205	150	260	109
M16	100	73	125	92	190	140	240	175	275	200	350	225	320	240	400	300
M18	135	100	175	125	260	195	330	250	375	275	475	350	440	325	560	410
M20	190	140	240	180	375	275	475	350	530	400	675	500	625	460	800	580
M22	260	190	330	250	510	375	650	475	725	540	925	675	850	625	1075	800
M24	330	250	425	310	650	475	825	600	925	675	1150	850	1075	800	1350	1000
M27	490	360	625	450	950	700	1200	875	1350	1000	1700	1250	1600	1150	2000	1500
M30	675	490	850	625	1300	950	1650	1200	1850	1350	2300	1700	2150	1600	2700	2000
M33	900	675	1150	850	1750	1300	2200	1650	2500	1850	3150	2350	2900	2150	3700	2750
M36	1150	850	1450	1075	2250	1650	2850	2100	3200	2350	4050	3000	3750	2750	4750	3500

DO NOT use these hand torque values if a different torque value or tightening procedure is given for a specific application. Torque values listed are for general use only and include a ±10% variance factor. Check tightness of fasteners periodically. DO NOT use air powered wrenches.

Shear bolts are designed to fail under predetermined loads. Always replace shear bolts with identical grade.

Fasteners should be replaced with the same grade. Make sure fastener threads are clean and that you properly start thread engagement. This will prevent them from failing when tightening.

When bolt and nut combination fasteners are used, torque values should be applied to the **NUT** instead of the bolt head.

Tighten toothed or serrated-type lock nuts to the full torque value.

^a "Lubricated" means coated with a lubricant such as engine oil, or fasteners with phosphate and oil coatings. "Dry" means plain or zinc plated (yellow dichromate - Specification JDS117) without any lubrication.

Reference: JDS—G200.

LUBRICANTS

HYDROSTATIC TRANSMISSION & HYDRAULIC OIL

Use the appropriate oil viscosity based on these air temperature ranges. Operating outside of these recommended oil air temperature ranges may cause premature hydrostatic transmission or hydraulic system failures.

IMPORTANT: Mixing of LOW VISCOSITY HY-GARD® and HY-GARD® oils is permitted. DO NOT mix any other oils in this transmission. DO NOT use engine oil or “Type F” (Red) Automatic Transmission Fluid in this transmission.

The following John Deere transmission and hydraulic oil is **PREFERRED**:

- **LOW VISCOSITY HY-GARD®—JDM J20D.**

The following John Deere oil is **also recommended** if above preferred oil is not available:

- **HY-GARD®—JDM J20C.**

Other oils may be used if above recommended John Deere oils are not available, provided they meet one of the following specifications:

- John Deere Standard JDM J20D;
- John Deere Standard JDM C.

the following publications to recommend the proper oil for your customers:

- Module DX,ANTI in JDS-G135;
- Section 530, Lubricants & Hydraulics, of the John Deere Merchandise Sales Guide;
- Lubrication Sales Manual PI7032.



ALTERNATIVE LUBRICANTS

Conditions in certain geographical areas outside the United States and Canada may require different lubricant recommendations than these printed in this manual or the operator's manual. Consult with your John Deere Dealer, or Sales Branch to obtain the alternative lubricant recommendations.

LUBRICANT STORAGE

This machine can operate at top efficiency only if clean lubricants are used.

Use clean containers to handle all lubricants. Store them in an area protected from dust, moisture, and other contamination. Store drums on their sides.

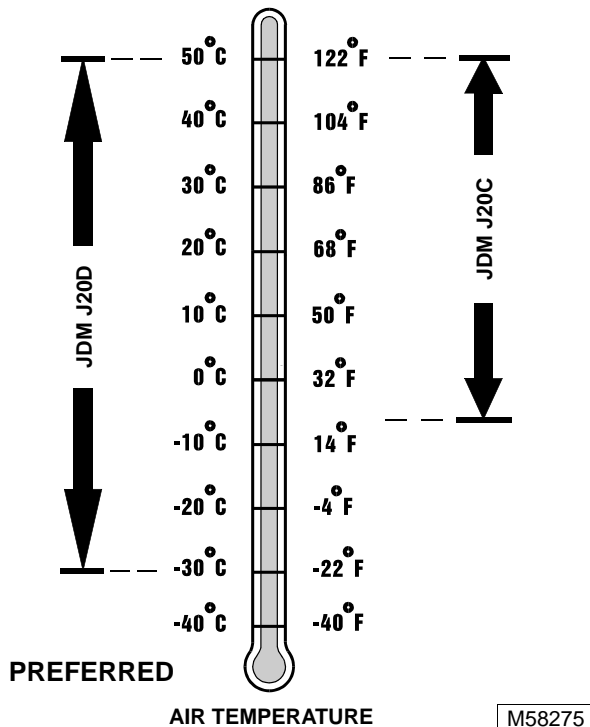

John Deere Dealers: You may want to cross-reference

Thank you very much for your reading. Please Click Here. Then Get COMPLETE MANUAL. NO WAITING



NOTE:

If there is no response to click on the link above, please download the PDF document first and then click on it.

CHASSIS GREASE

IMPORTANT: ONLY use a quality grease in this application. DO NOT mix any other greases in this application. DO NOT use any BIO-GREASE in this application.

The following John Deere greases are **PREFERRED**:

- **MOLY HIGH-TEMPERATURE EP GREASE®—JDM J25C, NLGI Grade 2;**
- **HIGH-TEMPERATURE EP GREASE®—JDM J13E4, NLGI Grade 2.**
- **GREASE-GARD™—JDM J25C, NLGI Grade 2.**

Other greases may be used if above preferred John Deere greases are not available, provided they meet one of the following specifications:

- **John Deere Standard JDM J25C, NLGI Grade 2;**
- **John Deere Standard JDM J13E4, NLGI Grade 2.**

IMPORTANT: If minimum air temperature should fall below $-20\text{ }^{\circ}\text{C}$ ($-4\text{ }^{\circ}\text{F}$), the grease must be heated to at least five degrees above the lower limit before start-up or components may be damaged.

John Deere Dealers: You may want to cross-reference the following publications to recommend the proper grease for your customers:

- **Module DX,GREA1 in JDS-G135;**
- **Section 530, Lubricants & Hydraulics, of the John Deere Merchandise Sales Guide;**
- **Lubrication Sales Manual PI7032.**

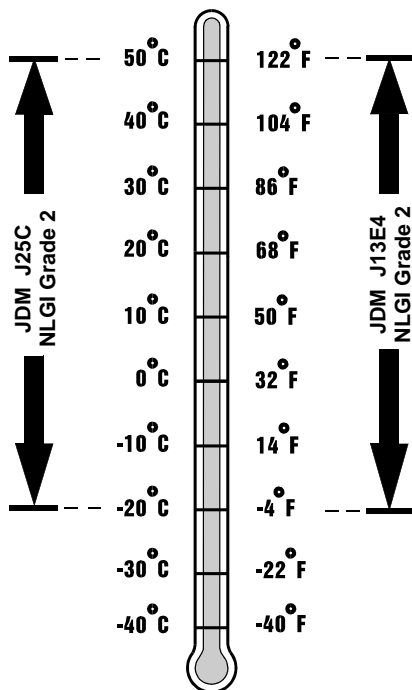

AIR TEMPERATURE

M58275

CONTENTS

	Page
SPECIFICATIONS	3
GENERAL SPECIFICATIONS.....	3
TORQUE SPECIFICATIONS.....	3
ADJUSTMENT SPECIFICATIONS.....	3
REPAIR SPECIFICATIONS.....	4
OTHER MATERIALS.....	4
HYDRAULIC SCHEMATIC.....	5
THEORY OF OPERATION.....	5
TROUBLESHOOTING	6
DIAGNOSIS	8
CHECKS, TESTS AND ADJUSTMENTS	9
HOPPER DRIFT CHECK.....	9
ROTARY BRUSH AND GROUND ROLLER ALIGNMENT CHECK.....	9
SWEEPING HEIGHT CHECK.....	10
GROUND ROLLER AND ROTARY BRUSH ALIGNMENT AND ADJUSTMENT.....	11
SIDE SKIRT HEIGHT CHECK.....	12
ROTARY BRUSH SEGMENT WEAR CHECK.....	12
REPAIR	13
RAISE HOPPER FOR SERVICE.....	13
GROUND ROLLER REMOVAL AND INSTALLATION.....	13
GROUND ROLLER INSPECTION AND REPAIR.....	14
GROUND ROLLER DECAL REPLACEMENT.....	14
BEARING LOCK COLLAR REMOVAL AND INSTALLATION.....	14
ROTARY BRUSH OR GROUND ROLLER BEARINGS.....	15
HYDRAULIC CYLINDER REMOVAL AND INSTALLATION.....	16
HYDRAULIC CYLINDER.....	17
HYDRAULIC CYLINDER COMPONENTS.....	18
ROTARY BRUSH MOTOR.....	19
ROTARY BRUSH MOTOR EXPLODED VIEW.....	20
ROTARY BRUSH.....	23
WHEEL SPINDLE EXPLODED VIEW.....	25
WHEEL SPINDLE.....	26
WHEEL AND SPINDLE.....	26
WHEEL SCRAPER REMOVAL AND INSTALLATION.....	26
HOPPER FRAME.....	27
HOPPER COMPONENTS.....	29
HOPPER.....	30
FRONT SHIELD REMOVAL AND INSTALLATION.....	30
HOPPER DOOR—EXPLODED VIEW.....	31
HOPPER SIDE SHIELDS AND SKIRTS—EXPLODED VIEW.....	31
REPLACEMENT HOPPER—EXPLODED VIEW.....	32
HOPPER DOOR REMOVAL AND INSTALLATION.....	32
HOPPER SIDE SHIELDS AND SKIRTS REMOVAL AND INSTALLATION.....	32
REPLACEMENT HOPPER INSTALLATION.....	32

