

F735 Front Mower

TECHNICAL MANUAL

**John Deere
Worldwide Commercial and
Consumer Equipment Division**

TM1597 (Dec99)

Safety



Specifications and Information



Diesel Engine



Electrical



Hydrostatic Power Train



Steering



Brakes



Hydraulics



Attachments



Miscellaneous





RECOGNIZE SAFETY INFORMATION



This is the safety-alert symbol. When you see this symbol on your machine or in this manual, be alert to the potential for personal injury.

Follow recommended precautions and safe servicing practices.

Understand Signal Words

A signal word—DANGER, WARNING, or CAUTION—is used with the safety-alert symbol. DANGER identifies the most serious hazards.

DANGER or WARNING safety signs are located near specific hazards. General precautions are listed on CAUTION safety signs. CAUTION also calls attention to safety messages in this manual.

REPLACE SAFETY SIGNS



Replace missing or damaged safety signs. See the machine operator's manual for correct safety sign placement.

HANDLE FLUIDS SAFELY—AVOID FIRES

Be Prepared for Emergencies

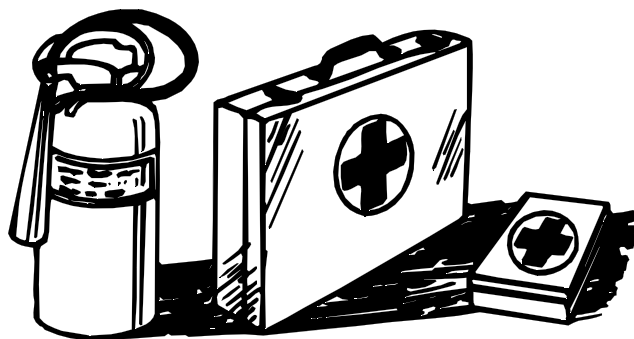

When you work around fuel, do not smoke or work near heaters or other fire hazards.

Store flammable fluids away from fire hazards. Do not incinerate or puncture pressurized containers.

Make sure machine is clean of trash, grease, and debris.

Do not store oily rags; they can ignite and burn spontaneously.

Be prepared if a fire starts.

Keep a first aid kit and fire extinguisher handy.

Keep emergency numbers for doctors, ambulance service, hospital, and fire department near your telephone.

USE CARE IN HANDLING AND SERVICING BATTERIES

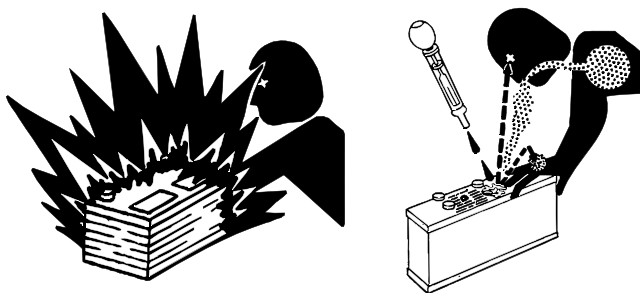

Prevent Battery Explosions

- Keep sparks, lighted matches, and open flame away from the top of battery. Battery gas can explode.
- Never check battery charge by placing a metal object across the posts. Use a voltmeter or hydrometer.
- Do not charge a frozen battery; it may explode. Warm battery to 16°C (60°F).

Prevent Acid Burns

- Sulfuric acid in battery electrolyte is poisonous. It is strong enough to burn skin, eat holes in clothing, and cause blindness if splashed into eyes.
- **Avoid acid burns by:**
 1. Filling batteries in a well-ventilated area.
 1. Wearing eye protection and rubber gloves.
 1. Avoiding breathing fumes when electrolyte is added.
 1. Avoiding spilling or dripping electrolyte.
 1. Using proper jump start procedure.
- **If you spill acid on yourself:**
 1. Flush your skin with water.
 1. Apply baking soda or lime to help neutralize the acid.
 1. Flush your eyes with water for 10—15 minutes.
 1. Get medical attention immediately.
- **If acid is swallowed:**
 1. Drink large amounts of water or milk.
 1. Then drink milk of magnesia, beaten eggs, or vegetable oil.
 1. Get medical attention immediately.

USE CARE AROUND HIGH-PRESSURE FLUID LINES

Avoid High-Pressure Fluids

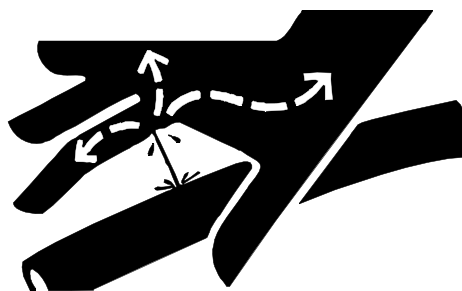

Escaping fluid under pressure can penetrate the skin causing serious injury.

Avoid injury from escaping fluid under pressure by stopping the engine and relieving pressure in the system before disconnecting or connecting hydraulic or other lines. Tighten all connections before applying pressure.

Search for leaks with a piece of cardboard. Protect hands and body from high pressure fluids.

If an accident occurs, see a doctor immediately. Any fluid injected into the skin must be surgically removed within a few hours or gangrene may result. Doctors unfamiliar with this type of injury should reference a knowledgeable medical source. Such information is available from Deere & Company Medical Department in Moline, Illinois, U.S.A.

Avoid Heating Near Pressurized Fluid Lines



Flammable spray can be generated by heating near pressurized fluid lines, resulting in severe burns to yourself and bystanders. Do not heat by welding, soldering, or using a torch near pressurized fluid lines or other flammable materials. Pressurized lines can be accidentally cut when heat goes beyond the immediate flame area.



USE SAFE SERVICE PROCEDURES

Wear Protective Clothing

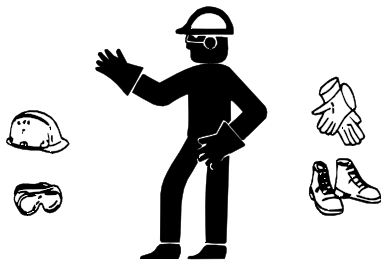

Wear close fitting clothing and safety equipment appropriate to the job.

Prolonged exposure to loud noise can cause impairment or loss of hearing. Wear a suitable hearing protective device such as earmuffs or earplugs to protect against objectionable or uncomfortable loud noises.

Operating equipment safely requires the full attention of the operator. Do not wear radio or music headphones while operating machine.

Service Machines Safely

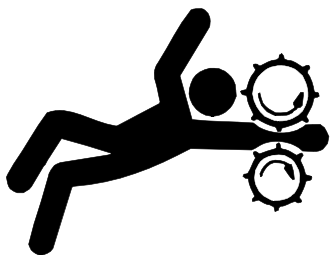

Tie long hair behind your head. Do not wear a necktie, scarf, loose clothing, or necklace when you work near machine tools or moving parts. If these items were to get caught, severe injury could result.

Remove rings and other jewelry to prevent electrical shorts and entanglement in moving parts.

Use Proper Tools

Use tools appropriate to the work. Makeshift tools and procedures can create safety hazards. Use power tools only to loosen threaded parts and fasteners. For loosening and tightening hardware, use the correct size tools. **DO NOT** use U.S. measurement tools on metric fasteners. Avoid bodily injury caused by slipping wrenches. Use only service parts meeting John Deere specifications.

Park Machine Safely

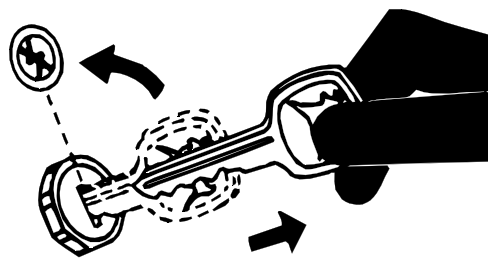

Before working on the machine:

1. Lower all equipment to the ground.
1. Stop the engine and remove the key.
1. Disconnect the battery ground strap.
1. Hang a "DO NOT OPERATE" tag in operator station.

Support Machine Properly and Use Proper Lifting Equipment

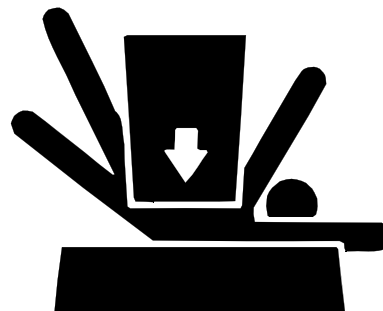

If you must work on a lifted machine or attachment, securely support the machine or attachment.

Do not support the machine on cinder blocks, hollow tiles, or props that may crumble under continuous load. Do not work under a machine that is supported solely by a jack. Follow recommended procedures in this manual.

Lifting heavy components incorrectly can cause severe injury or machine damage. Follow recommended procedure for removal and installation of components in the manual.

Work in Clean Area

Before starting a job:

1. Clean work area and machine.
1. Make sure you have all necessary tools to do your job.
1. Have the right parts on hand.
1. Read all instructions thoroughly; do not attempt shortcuts.

Using High-Pressure Washers

Directing pressurized water at electronic/electrical components or connectors, bearings, hydraulic seals, fuel injection pumps or other sensitive parts and components may cause product malfunctions. Reduce pressure and spray at a 45 to 90 degree angle.

Illuminate Work Area Safely

Illuminate your work area adequately but safely. Use a portable safety light for working inside or under the machine. Make sure the bulb is enclosed by a wire cage. The hot filament of an accidentally broken bulb can ignite spilled fuel or oil.

Work in Ventilated Area

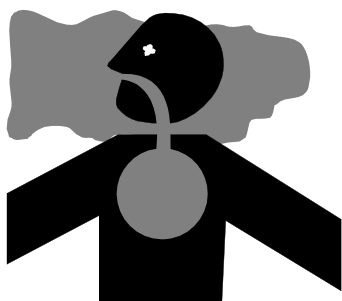

Engine exhaust fumes can cause sickness or death. If it is necessary to run an engine in an enclosed area, remove the exhaust fumes from the area with an exhaust pipe extension.

If you do not have an exhaust pipe extension, open the doors and get outside air into the area.

WARNING: California Proposition 65 Warning

Diesel engine exhaust and some of its constituents are known to the State of California to cause cancer, birth defects, and other reproductive harm.

Gasoline engine exhaust from this product contains chemicals known to the State of California to cause cancer, birth defects, or other reproductive harm.

Remove Paint Before Welding or Heating

Avoid potentially toxic fumes and dust. Hazardous fumes can be generated when paint is heated by welding, soldering, or using a torch. Do all work outside or in a well-ventilated area. Dispose of paint and solvent properly. Remove paint before welding or heating. If you sand or grind paint, avoid breathing the dust. Wear an approved respirator. If you use solvent or paint stripper, remove stripper with soap and water before welding. Remove solvent or paint stripper containers and other flammable material from area. Allow fumes to disperse at least 15 minutes before welding or heating.

Avoid Harmful Asbestos Dust

Avoid breathing dust that may be generated when handling components containing asbestos fibers. Inhaled asbestos fibers may cause lung cancer.

Components in products that may contain asbestos fibers are brake pads, brake band and lining assemblies, clutch plates, and some gaskets. The asbestos used in these components is usually found in a resin or sealed in some way. Normal handling is not hazardous as long as airborne dust containing asbestos is not generated.

Avoid creating dust. Never use compressed air for cleaning. Avoid brushing or grinding material containing asbestos. When servicing, wear an approved respirator. A special vacuum cleaner is recommended to clean asbestos. If not available, apply a mist of oil or water on the material containing asbestos. Keep bystanders away from the area.



SERVICE TIRES SAFELY

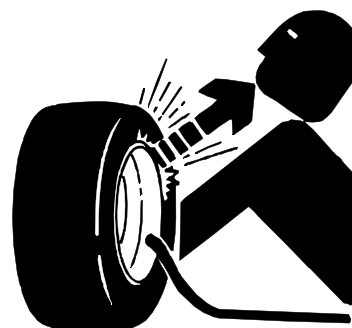

Explosive separation of a tire and rim parts can cause serious injury or death.

Do not attempt to mount a tire unless you have the proper equipment and experience to perform the job. Always maintain the correct tire pressure. Do not inflate the tires above the recommended pressure. Never weld or heat a wheel and tire assembly. The heat can cause an increase in air pressure resulting in a tire explosion. Welding can structurally weaken or deform the wheel.

When inflating tires, use a clip-on chuck and extension hose long enough to allow you to stand to one side and NOT in front of or over the tire assembly. Use a safety cage if available.

Check wheels for low pressure, cuts, bubbles, damaged rims or missing lug bolts and nuts.



AVOID INJURY FROM ROTATING BLADES, AUGERS AND PTO SHAFTS

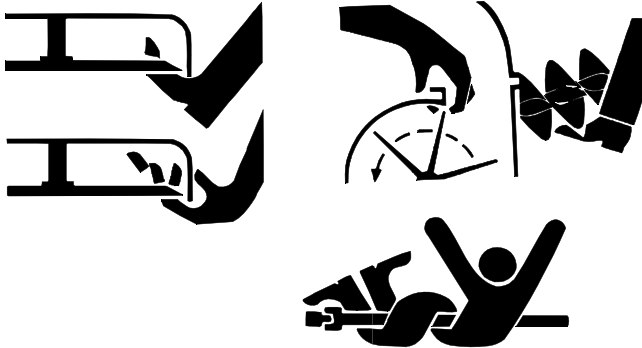

Keep hands and feet away while machine is running. Shut off power to service, lubricate or remove mower blades, augers or PTO shafts.

SERVICE COOLING SYSTEM SAFELY



Explosive release of fluids from pressurized cooling system can cause serious burns.

Shut off machine. Remove filler cap only when cool enough to touch with bare hands. Slowly loosen cap to first stop to relieve pressure before removing completely.

HANDLE CHEMICAL PRODUCTS SAFELY

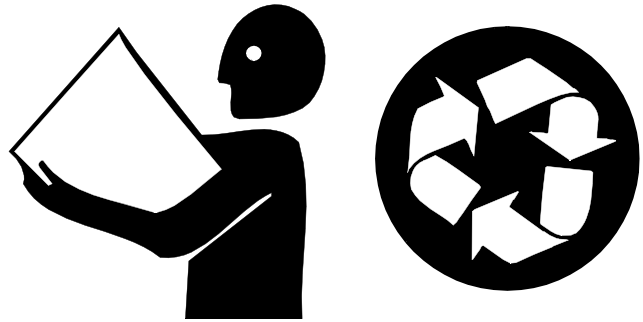

Direct exposure to hazardous chemicals can cause serious injury. Potentially hazardous chemicals used with John Deere equipment include such items as lubricants, coolants, paints, and adhesives.

A Material Safety Data Sheet (MSDS) provides specific details on chemical products: physical and health hazards, safety procedures, and emergency response techniques. Check the MSDS before you start any job using a hazardous chemical. That way you will know exactly what the risks are and how to do the job safely. Then follow procedures and recommended equipment.

Dispose of Waste Properly

Improperly disposing of waste can threaten the environment and ecology. Potentially harmful waste used with John Deere equipment includes such items as oil, fuel, coolant, brake fluid, filters, and batteries. Use leakproof containers when draining fluids. Do not use food or beverage containers that may mislead someone into drinking from them. Do not pour waste onto the ground, down a drain, or into any water source. Inquire on the proper way to recycle or dispose of waste from your local environmental or recycling center, or from your John Deere dealer.

LIVE WITH SAFETY



Before returning machine to customer, make sure machine is functioning properly, especially the safety systems. Install all guards and shields.

CONTENTS

Page



SPECIFICATIONS AND INFORMATION

SPECIFICATIONS	2
GENERAL VEHICLE SPECIFICATIONS	2
METRIC FASTENER TORQUE VALUES	4
METRIC FASTENER TORQUE VALUE—GRADE 7	5
INCH FASTENER TORQUE VALUES	6
O-RING SEAL SERVICE RECOMMENDATIONS	
FACE SEAL FITTINGS WITH INCH STUD ENDS TORQUE	7
FACE SEAL FITTINGS WITH METRIC STUD ENDS TORQUE	8
O-RING FACE SEAL FITTINGS	9
O-RING BOSS FITTINGS	9
DIESEL FUEL SPECIFICATIONS	10
DIESEL FUEL SPECIFICATIONS	10
LUBRICITY	10
STORAGE	10
ENGINE OIL SPECIFICATIONS	11
4-CYCLE DIESEL ENGINE OIL—NORTH AMERICA	11
4-CYCLE DIESEL ENGINE OIL—EUROPE	11
BREAK-IN DIESEL ENGINE OIL—NORTH AMERICA	12
BREAK-IN DIESEL ENGINE OIL—EUROPE	12
OILS AND LUBRICANTS SPECIFICATIONS	13
HYDROSTATIC TRANSMISSION AND HYDRAULIC OIL	13
GEAR CASE OIL—NORTH AMERICA	13
GEAR CASE OIL—EUROPE	14
ANTI-CORROSION GREASE SPECIFICATIONS	14
CHASSIS AND MOWER SPINDLE GREASE	15
ALTERNATIVE LUBRICANTS	15
SYNTHETIC LUBRICANTS	15
LUBRICANT STORAGE	15
MIXING OF LUBRICANTS	15
OIL FILTERS	15
COOLANT SPECIFICATIONS	16
DIESEL ENGINE COOLANT	16
DIESEL ENGINE COOLANT DRAIN INTERVAL	16
SERIAL NUMBER LOCATION	17
MACHINE IDENTIFICATION NUMBER	17
ENGINE SERIAL NUMBER	17
STEERING VALVE SERIAL NUMBER	17
HYDROSTATIC TRANSAXLE SERIAL NUMBER	17
MOWER DECK SERIAL NUMBER	17
PTO GEARBOX SERIAL NUMBER	17

SPECIFICATIONS

GENERAL VEHICLE SPECIFICATIONS



ENGINE

Engine Yanmar 2V78
 Engine Model Number 2008D001
 Type Vertical Shaft, 4-Cycle, Diesel
 Number of Cylinders 2 (V Twin)
 Power Output@ 3000 RPM 13.4 kW (18 hp)
 Displacement 749 cc (46 cu in.)
 Cylinder Bore x Stroke 78 mm (3.071 in.) x 78.4 mm (3.087 in.)
 Aspiration Natural
 Cooling System Liquid Cooled
 Lubricating System Forced Lubrication with Trochoid Pump
 Lubricant Capacity (with Filter) 2.27 L (2.4 qt)
 Cooling System Capacity (Total) 3.9 L (4.12 qt)
 Radiator Capacity 2.5 L (2.643 qt)
 Coolant Recovery Tank Capacity 0.3 L (0.317 qt)
 Air Cleaner Dual Element

FUEL SYSTEM

Fuel Tank Location Left Side, Behind Operator
 Fuel Tank Capacity 26.5 L (7 gal)
 Fuel Filter Replaceable In-Line

ELECTRICAL

Charging System Flywheel Stator
 Charging Capacity 20 Amp Regulated

POWER TRAIN

Manufacturer Kanzaki
 Transaxle Hydrostatic
 Travel Speeds at Full Engine RPM
 Forward 0—11.3 km/h (0—7 mph)
 Reverse 0—4.8 km/h (0—3 mph)
 Transmission/Hydraulic Oil Capacity 4.4 L (4.7 qt)

STEERING

Type Power, Hydraulic, Rear Wheels

BRAKES

Location Transaxle
 Type Drum and Shoes

HYDRAULICS

Attachment Lift Hydraulic
 Type Mechanical Spool Valve

PTO DRIVE

Type Gear Box
 Clutch Type Engine Mounted Electric

MOWER DECK (48-INCH)

Cutting Width 122 cm (48 in.)
 Cutting Height 25—100 mm (1—4 in.)
 Number of Blades 3

MOWER DECK (54-INCH)

Cutting Width 137 cm (54 in.)
 Cutting Height 25—100 (1—4 in.)
 Number of Blades 3

MOWER DECK (60-INCH)

Cutting Width 152 cm (60 in.)
 Cutting Height 25—100 mm (1—4 in.)
 Number of Blades 3

WHEELS AND TIRES











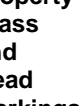









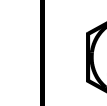
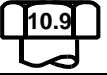

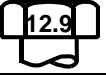
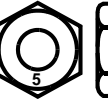

Drive Tires (Front) 20 x 10.00-8
 Rear Tires 15 x 6.00-6
 Mower Deck Caster Wheels 9 x 3.5-4

WEIGHTS AND DIMENSIONS

Weight (Without Mower Deck) 494 kg (1089 lb)
 Wheelbase 1.0 m (39.4 in.)
 Overall Height 1.2 m (47.6 in.)
 Overall Width (Without Mower Deck) 0.97 m (38.8 in.)
 Overall Length (Without Mower Deck) 2.1 m (81.0 in.)
 Sound Rating (With Mower Deck) 90 dBa
 Sound Rating (Without Mower Deck) 85 dBa



METRIC FASTENER TORQUE VALUES

 Property Class and Head Markings	4.8   	8.8   	9.8   	10.9   	12.9   
	Property Class and Nut Markings	5   	10   	10   	12   

TS1163

SIZE	Class 4.8		Class 8.8 or 9.8				Class 10.9				Class 12.9					
	Lubricated ^a		Dry ^a		Lubricated ^a		Dry ^a		Lubricated ^a		Dry ^a		Lubricated ^a		Dry ^a	
	N•m	lb-ft	N•m	lb-ft	N•m	lb-ft	N•m	lb-ft	N•m	lb-ft	N•m	lb-ft	N•m	lb-ft	N•m	lb-ft
M6	4.8	3.5	6	4.5	9	6.5	11	8.5	13	9.5	17	12	15	11.5	19	14.5
M8	12	8.5	15	11	22	16	28	20	32	24	40	30	37	28	47	35
M10	23	17	29	21	43	32	55	40	63	47	80	60	75	55	95	70
M12	40	29	50	37	75	55	95	70	110	80	140	105	130	95	165	120
M14	63	47	80	60	120	88	150	110	175	130	225	165	205	150	260	109
M16	100	73	125	92	190	140	240	175	275	200	350	225	320	240	400	300
M18	135	100	175	125	260	195	330	250	375	275	475	350	440	325	560	410
M20	190	140	240	180	375	275	475	350	530	400	675	500	625	460	800	580
M22	260	190	330	250	510	375	650	475	725	540	925	675	850	625	1075	800
M24	330	250	425	310	650	475	825	600	925	675	1150	850	1075	800	1350	1000
M27	490	360	625	450	950	700	1200	875	1350	1000	1700	1250	1600	1150	2000	1500
M30	675	490	850	625	1300	950	1650	1200	1850	1350	2300	1700	2150	1600	2700	2000
M33	900	675	1150	850	1750	1300	2200	1650	2500	1850	3150	2350	2900	2150	3700	2750
M36	1150	850	1450	1075	2250	1650	2850	2100	3200	2350	4050	3000	3750	2750	4750	3500

DO NOT use these hand torque values if a different torque value or tightening procedure is given for a specific application. Torque values listed are for general use only and include a ±10% variance factor. Check tightness of fasteners periodically. DO NOT use air powered wrenches.

Shear bolts are designed to fail under predetermined loads. Always replace shear bolts with identical grade.

Fasteners should be replaced with the same class. Make sure fastener threads are clean and that you properly start thread engagement. This will prevent them from failing when tightening.

When bolt and nut combination fasteners are used, torque values should be applied to the **NUT** instead of the bolt head.

Tighten toothed or serrated-type lock nuts to the full torque value.

^a "Lubricated" means coated with a lubricant such as engine oil, or fasteners with phosphate and oil coatings. "Dry" means plain or zinc plated (yellow dichromate - Specification JDS117) without any lubrication.









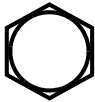

Reference: JDS-G200

**METRIC FASTENER TORQUE
VALUE—GRADE 7**

Size	Steel or Gray Iron Torque		Aluminum Torque	
	N•m	lb-ft	N•m	lb-ft
M6	11	8	8	6
M8	24	18	19	14
M10	52	38	41	30
M12	88	65	70	52
M14	138	102	111	82
M16	224	165	179	132



INCH FASTENER TORQUE VALUES

SAE Grade and Head Markings	1 or 2 ^b No Marks 	5  5.1  5.2 	8  8.2 
	2 No Marks 	5  	8  

TS1162

SIZE	Grade 1 ^b		Grade 2 ^b		Grade 5, 5.1 or 5.2		Grade 8 or 8.2									
	Lubricated ^a	Dry ^a	Lubricated ^a	Dry ^a	Lubricated ^a	Dry ^a	Lubricated ^a	Dry ^a								
	N•m	lb-ft	N•m	lb-ft	N•m	lb-ft	N•m	lb-ft	N•m	lb-ft	N•m	lb-ft	N•m	lb-ft	N•m	lb-ft
1/4	3.7	2.8	4.7	3.5	6	4.5	7.5	5.5	9.5	7	12	9	13.5	10	17	12.5
5/16	7.7	5.5	10	7	12	9	15	11	20	15	25	18	28	21	35	26
3/8	14	10	17	13	22	16	27	20	35	26	44	33	50	36	63	46
7/16	22	16	28	20	35	26	44	32	55	41	70	52	80	58	100	75
1/2	33	25	42	31	53	39	67	50	85	63	110	80	120	90	150	115
9/16	48	36	60	45	75	56	95	70	125	90	155	115	175	130	225	160
5/8	67	50	85	62	105	78	135	100	170	125	215	160	215	160	300	225
3/4	120	87	150	110	190	140	240	175	300	225	375	280	425	310	550	400
7/8	190	140	240	175	190	140	240	175	490	360	625	450	700	500	875	650
1	290	210	360	270	290	210	360	270	725	540	925	675	1050	750	1300	975
1-1/8	470	300	510	375	470	300	510	375	900	675	1150	850	1450	1075	1850	1350
1-1/4	570	425	725	530	570	425	725	530	1300	950	1650	1200	2050	1500	2600	1950
1-3/8	750	550	950	700	750	550	950	700	1700	1250	2150	1550	2700	2000	3400	2550
1-1/2	1000	725	1250	925	990	725	1250	930	2250	1650	2850	2100	3600	2650	4550	3350

DO NOT use these hand torque values if a different torque value or tightening procedure is given for a specific application. Torque values listed are for general use only and include a ±10% variance factor. Check tightness of fasteners periodically. DO NOT use air powered wrenches.

Shear bolts are designed to fail under predetermined loads. Always replace shear bolts with identical grade.

Fasteners should be replaced with the same grade. Make sure fastener threads are clean and that you properly start thread engagement. This will prevent them from failing when tightening.

When bolt and nut combination fasteners are used, torque values should be applied to the **NUT** instead of the bolt head.

Tighten toothed or serrated-type lock nuts to the full torque value.

^a "Lubricated" means coated with a lubricant such as engine oil, or fasteners with phosphate and oil coatings. "Dry" means plain or zinc plated (yellow dichromate - Specification JDS117) without any lubrication.

^b "Grade 2" applies for hex cap screws (not hex bolts) up to 152 mm (6-in.) long. "Grade 1" applies for hex cap screws over 152 mm (6-in.) long, and for all other types of bolts and screws of any length.

Reference: JDS-G200.

O-RING SEAL SERVICE RECOMMENDATIONS

FACE SEAL FITTINGS WITH INCH STUD ENDS TORQUE

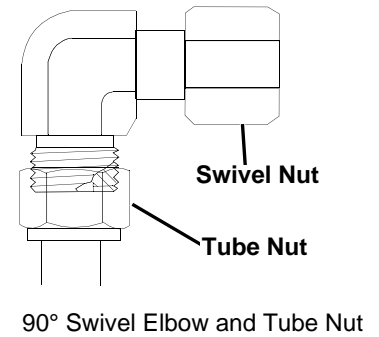
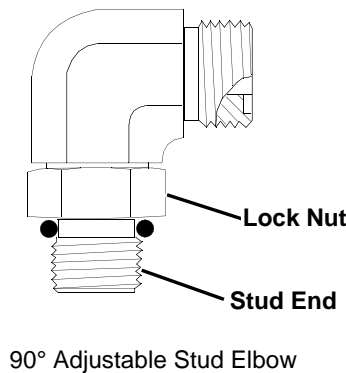
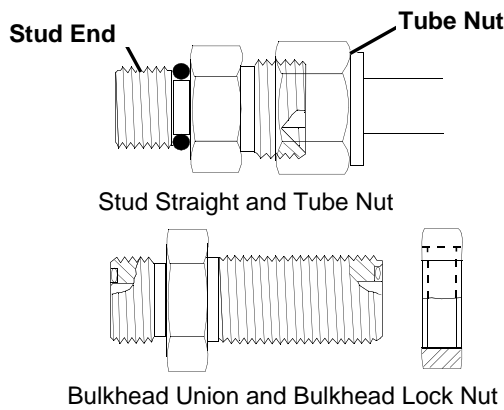

Nominal Tube OD/Hose ID				Face Seal Tube/Hose End					O-Ring Stud Ends		
Metric Tube OD	Inch Tube OD			Thread Size	Tube Nut/ Swivel Nut Torque		Bulkhead Lock Nut Torque		Thread Size	Straight Fitting or Lock Nut Torque	
	mm	Dash Size	in.		mm	in.	N•m	lb-ft		N•m	lb-ft
	-3	0.188	4.76						3/8-24	8	6
6	-4	0.250	6.35	9/16-18	16	12	12	9	7/16-20	12	9
8	-5	0.312	7.94						1/2-20	16	12
10	-6	0.375	9.52	11/16-16	24	18	24	18	9/16-18	24	18
12	-8	0.500	12.70	13/16-16	50	37	46	34	3/4-16	46	34
16	-10	0.625	15.88	1-14	69	51	62	46	7/8-14	62	46
	-12	0.750	19.05	1-3/16-12	102	75	102	75	1-1/16-12	102	75
22	-14	0.875	22.22	1-3/16-12	102	75	102	75	1-3/16-12	122	90
25	-16	1.000	25.40	1-7/16-12	142	105	142	105	1-5/16-12	142	105
32	-20	1.25	31.75	1-11/16-12	190	140	190	140	1-5/8-12	190	140
38	-24	1.50	38.10	2-12	217	160	217	160	1-7/8-12	217	160

NOTE: Torque tolerance is + 15 minus 20%.

FACE SEAL FITTINGS WITH METRIC STUD ENDS TORQUE

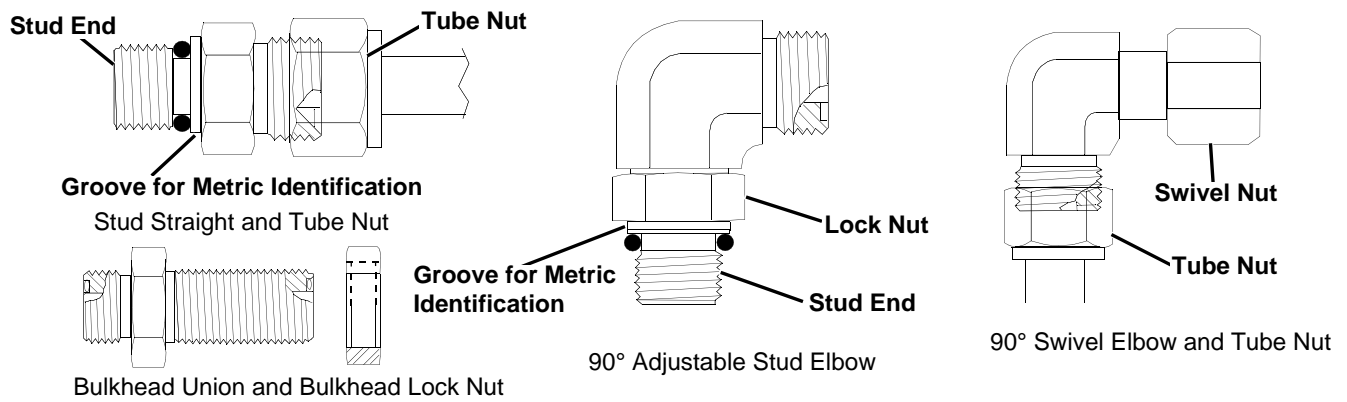

Nominal Tube OD/Hose ID				Face Seal Tube/Hose End						O-Ring Stud Ends, Straight Fitting or Lock Nut					
Metric Tube OD	Inch Tube OD			Thread Size	Hex Size	Tube Nut/ Swivel Nut Torque		Bulkhead Lock Nut Torque		Thread Size	Hex Size	Steel or Gray Iron Torque		Aluminum Torque	
	mm	Dash Size	in.			mm	in.	mm	N•m			lb-ft	N•m	lb-ft	mm
6	-4	0.250	6.35	9/16-18	17	16	12	12	9	M12X1.5	17	21	15.5	9	6.6
8	-5	0.312	7.94							M14X1.5	19	33	24	15	11
10	-6	0.375	9.52	11/16-16	22	24	18	24	18	M16X1.5	22	41	30	18	13
12	-8	0.500	12.70	13/16-16	24	50	37	46	34	M18X1.5	24	50	37	21	15
16	-10	0.625	15.88	1-14	30	69	51	62	46	M22X1.5	27	69	51	28	21
	-12	0.750	19.05	1-3/16-12	36	102	75	102	75	M27X2	32	102	75	46	34
22	-14	0.875	22.22	1-3/16-12	36	102	75	102	75	M30X2	36				
25	-16	1.000	25.40	1-7/16-12	41	142	105	142	105	M33X2	41	158	116	71	52
28										M38X2	46	176	130	79	58
32	-20	1.25	31.75	1-11/16-12	50	190	140	190	140	M42X2	50	190	140	85	63
38	-24	1.50	38.10	2-12	60	217	160	217	160	M48X2	55	217	160	98	72

NOTE: Torque tolerance is + 15 minus 20%.

Thank you very much for your reading. Please Click Here. Then Get COMPLETE MANUAL. NO WAITING



NOTE:

If there is no response to click on the link above, please download the PDF document first and then click on it.

O-RING FACE SEAL FITTINGS

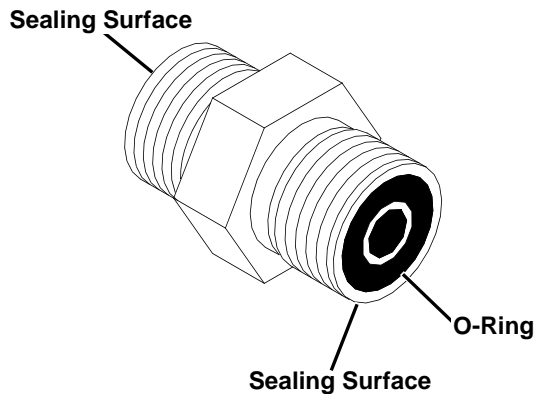

1. Inspect the fitting sealing surfaces. They must be free of dirt or defects.
2. Inspect the O-ring. It must be free of damage or defects.
3. Lubricate O-rings and install into groove using petroleum jelly to hold in place.
4. Push O-ring into the groove with plenty of petroleum jelly so O-ring is not displaced during assembly.
5. Index angle fittings and tighten by hand pressing joint together to insure O-ring remains in place.
6. Tighten fitting or nut to torque value shown on the chart per dash size stamped on the fitting. Do not allow hoses to twist when tightening fittings.

O-RING BOSS FITTINGS

1. Inspect boss O-ring boss seat. It must be free of dirt and defects. If repeated leaks occur, inspect for defects with a magnifying glass. Some raised defects can be removed with a slip stone.

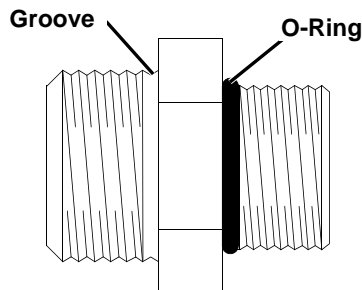

2. Put hydraulic oil or petroleum jelly on the O-ring. Place electrical tape over the threads to protect O-ring from nicks. Slide O-ring over the tape and into the groove of fitting. Remove tape.

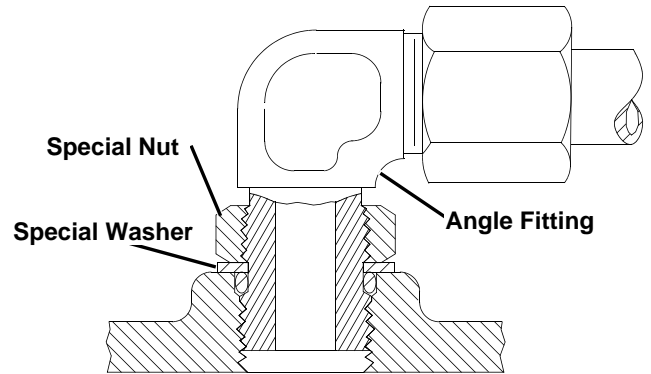

3. For angle fittings, loosen special nut and push special washer against threads so O-ring can be installed into the groove of fitting.
4. Turn fitting into the boss by hand until special washer or washer face (straight fitting) contacts boss face and O-ring is squeezed into its seat.
5. To position angle fittings, turn the fitting counter-clockwise a maximum of one turn.
6. Tighten straight fittings to torque value shown on chart. For angle fittings, tighten the special nut to value shown in the chart while holding body of fitting with a wrench.

STRAIGHT FITTING OR SPECIAL NUT TORQUE

Thread Size	Torque ^a		Number of Flats ^b
	N•m	lb-ft	
3/8-24 UNF	8	(6)	2
7/16-20 UNF	12	(9)	2
1/2-20 UNF	16	(12)	2
9/16-18 UNF	24	(18)	2
3/4-16 UNF	46	(34)	2
7/8-14 UNF	62	(46)	1-1/2
1-1/16-12 UN	102	(75)	1
1-3/16-12 UN	122	(90)	1
1-5/16-12 UN	142	(105)	3/4
1-5/8-12 UN	190	(140)	3/4
1-7/8-12 UN	217	(160)	1/2

a. Torque tolerance is ± 10 percent.

b. To be used if a torque wrench cannot be used. After tightening fitting by hand, put a mark on nut or boss; then tighten special nut or straight fitting the number of flats shown.

DIESEL FUEL SPECIFICATIONS

In general, diesel fuels are blended to satisfy the low air temperature requirements of the geographical area in which they are sold.

In **North America**, diesel fuel is usually specified to **ASTM D975** and sold as either **Grade 1** for cold air temperatures or **Grade 2** for warm air temperatures.

In **Europe**, diesel fuel is usually specified to **EN590** and sold in 5 different classes or 6 different grades.

If diesel fuels being supplied in your area **DO NOT** meet any of the above specifications, use diesel fuels with the following equivalent properties:

- **Cetane Number 40 (minimum)**

A cetane number **greater than 50 is preferred**, especially for air temperatures below -20°C (-4°F) or elevations above 1500 m (5000 ft).

- **Cold Filter Plugging Point (CFPP)**

The temperature at which diesel fuel **begins to cloud or jell**. Use diesel fuels with a CFPP which is at least 5°C (9°F) below the expected low air temperature.

- **Sulfur Content of 0.05% (maximum)**

Diesel fuels for highway use in the United States now require sulfur content to be **less than 0.05%**.

If diesel fuel being used has a sulfur content **greater than 0.5%**, **reduce the service interval for engine oil and filter by 50%**.

Bio-Diesel Fuels with bio-degradable properties that meet specification DIN 51606 or equivalent may be used.

Consult your local diesel fuel distributor for properties of the diesel fuel available in your area.



CAUTION

California Proposition 65 Warning: Diesel engine exhaust and some of its elements from this product are known to the State of California to cause cancer, birth defects, or other reproductive harm.

LUBRICITY

Diesel fuel must have adequate lubricity to ensure proper operation and durability of fuel injection system components. Fuel lubricity should pass a **minimum of 3300 gram load level** as measured by the **BOCLE** scuffing test.

STORAGE

IMPORTANT: DO NOT USE GALVANIZED CONTAINERS—diesel fuel stored in galvanized containers reacts with zinc coating in the container to form zinc flakes. If fuel contains water, a zinc gel will also form. The gel and flakes will quickly plug fuel filters and damage fuel injectors and fuel pumps.

It is recommended that diesel fuel be stored **ONLY** in a clean, approved **POLYETHYLENE PLASTIC** container **WITHOUT** any metal screen or filter. This will help prevent any accidental sparks from occurring. Store fuel in an area that is well ventilated to prevent possible igniting of fumes by an open flame or spark. This includes any appliance with a pilot light.

IMPORTANT: Keep all dirt, scale, water or other foreign material out of fuel.

Keep fuel in a safe, protected area and in a clean, properly marked ("**DIESEL FUEL**") container. **DO NOT** use de-icers to attempt to remove water from fuel.

DO NOT depend on fuel filters to remove water from fuel. It is recommended that a water separator be installed in the storage tank outlet. **BE SURE** to properly discard unstable or contaminated diesel fuel and/or their containers when necessary.