

John Deere JD540-B Skidder and Grapple Skidder Repair

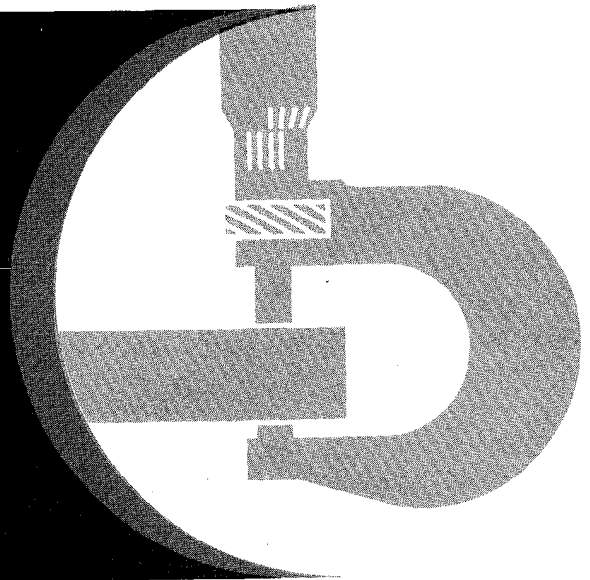

TECHNICAL MANUAL

TM-1139 (Oct-87)

JD540-B SKIDDER - GRAPPLE SKIDDER

Technical Manual
TM-1139 (Oct-87)

SECTION AND GROUP CONTENTS

SECTION I - GENERAL INFORMATION

- Group I - Contents
- Group II - Introduction and Safety Information
- Group III - General Specifications
- Group IV - Predelivery, Delivery and After-Sale Services
- Group V - Lubrication

SECTION 1 - WHEELS

- Group 0110 - Powered Wheels and Fastenings
- Group 0149 - Weights
- Group 0199 - Specifications and Special Tools

SECTION 2 - AXLES AND SUSPENSION SYSTEMS

- Group 0201 - Drive Axle Housing and Support
- Group 0210 - Differential or Bevel Drive
- Group 0225 - Input Drive Shafts and U-Joints
- Group 0250 - Axle Shaft, Bearings, Reduction Gears
- Group 0299 - Specifications and Special Tools

SECTION 3 - TRANSMISSION

- Group 0315 - Controls
- Group 0341 - Housing and Covers
- Group 0350 - Gears, Shafts, Bearings and Power Shift Clutch
- Group 0360 - Hydraulic System
- Group 0370 - Clutch Disconnect and Controls
- Group 0399 - Specifications and Special Tools

SECTION 4 - ENGINE

- Group 0400 - Engine Removal and Installation
- Group 0401 - Crankshaft and Main Bearings
- Group 0402 - Camshaft and Valve Actuating Means
- Group 0403 - Connecting Rods and Pistons
- Group 0404 - Cylinder Block
- Group 0407 - Oiling System
- Group 0408 - Ventilating System
- Group 0409 - Cylinder Head and Valves
- Group 0410 - Exhaust Manifold
- Group 0413 - Fuel Injection System
- Group 0415 - Engine Balancer
- Group 0416 - Turbocharger
- Group 0417 - Water Pump
- Group 0418 - Thermostats, Hsgs. and Water Piping
- Group 0419 - Oil Cooler
- Group 0420 - Fuel Filter
- Group 0421 - Fuel Transfer Pump
- Group 0422 - Starting Motor and Fastenings
- Group 0433 - Flywheel, Housing and Fastenings
- Group 0499 - Specifications and Special Tools

SECTION 5 - ENGINE AUXILIARY SYSTEMS

- Group 0505 - Cold Weather Starting Aids
- Group 0510 - Cooling Systems
- Group 0515 - Speed Controls
- Group 0520 - Intake System
- Group 0530 - External Exhaust Systems
- Group 0540 - Mounting Frame
- Group 0560 - External Fuel Supply Systems
- Group 0599 - Specifications and Special Tools

Continued on next page

The specifications and design information contained in this manual were correct at the time it was printed. It is John Deere's policy to continually improve and update our machines. Therefore, the specifications and design information are subject to change without notice.

Copyright© 1987
DEERE & COMPANY
Moline, Illinois
All Rights Reserved

Previous Editions
Copyright© 1983 Deere & Company
Copyright© 1980 Deere & Company
Copyright© 1979 Deere & Company
Copyright© 1977 Deere & Company
Copyright© 1976 Deere & Company

SECTION 9 - STEERING SYSTEM

- Group 0930 - Emergency Steering
- Group 0960 - Hydraulic System
- Group 0999 - Specifications and Special Tools

SECTION 10 - SERVICE BRAKES

- Group 1011 - Active Elements
- Group 1015 - Controls Linkage
- Group 1060 - Hydraulic System
- Group 1099 - Specifications and Special Tools

SECTION 11 - EMERGENCY BRAKES

- Group 1111 - Active Elements
- Group 1115 - Controls Linkage
- Group 1199 - Specifications and Special Tools

SECTION 16 - ELECTRICAL SYSTEM

- Group 1671 - Batteries, Supports and Cables
- Group 1672 - Alternator, Regulator and Charging System Wiring
- Group 1673 - Lighting System
- Group 1674 - Wiring Harness and Switches
- Group 1676 - Instruments and Indicators
- Group 1699 - Specifications and Special Tools

SECTION 17 - FRAME, CHASSIS OR SUPPORTING STRUCTURE

- Group 1740 - Frame Installation
- Group 1746 - Frame Bottom Guards
- Group 1799 - Specifications and Special Tools

SECTION 18 - OPERATOR'S STATION

- Group 1807 - Special Noise Control Items
- Group 1810 - Operator Enclosure
- Group 1821 - Seat
- Group 1830 - Heating and Air Conditioning
- Group 1899 - Specifications and Special Tools

SECTION 19 - SHEET METAL

- Group 1910 - Hood or Engine Enclosure
- Group 1921 - Grille and Grille Housing

SECTION 20 - SAFETY, CONVENIENCE AND MISCELLANEOUS

- Group 2003 - Fire Extinguisher
- Group 2004 - Horn
- Group 2006 - Cigar Lighter

SECTION 21 - HYDRAULIC SYSTEM

- Group 2160 - Hydraulic System
- Group 2199 - Specifications and Special Tools

SECTION 30 - WINCH

- Group 3041 - Winch Housing and Mounting Structure
- Group 3050 - Winch Drive and Clutches
- Group 3060 - Hydraulic System
- Group 3099 - Specifications and Special Tools

SECTION 32 - BULLDOZERS

- Group 3201 - Blades
- Group 3215 - Controls Linkage
- Group 3260 - Hydraulic System
- Group 3299 - Specifications and Special Tools

SECTION 37 - ARCH OR BOOM, OR CRANES

- Group 3740 - Frames
- Group 3760 - Hydraulic System
- Group 3799 - Specifications and Special Tools

SECTION 38 - GRAPPLE

- Group 3803 - Grapple Mechanism
- Group 3815 - Control Linkage
- Group 3860 - Hydraulic System
- Group 3899 - Specifications and Special Tools

SECTION 40 - PTO OR WINCH DRIVE

- Group 4025 - Input Drive Shafts
- Group 4051 - Gears, Shafts and Bearings
- Group 4099 - Specifications and Special Tools

Group II INTRODUCTION AND SAFETY INFORMATION

INTRODUCTION

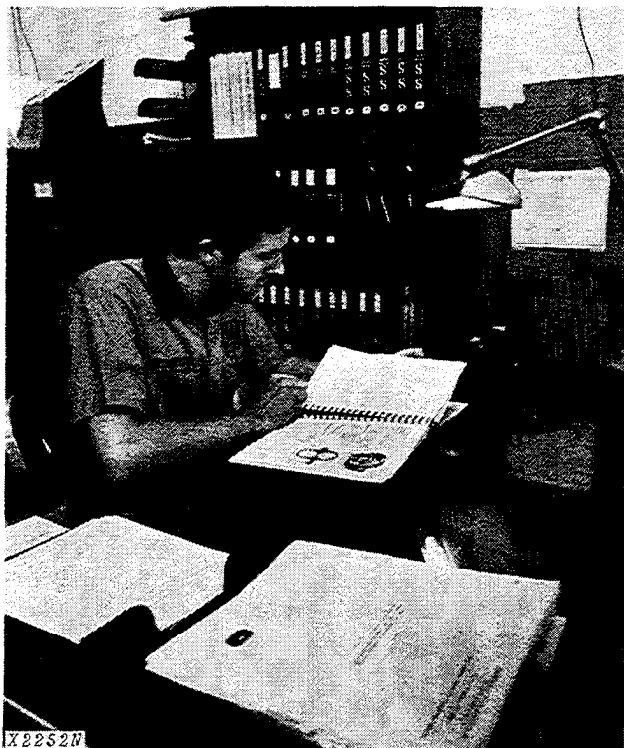

Use FOS Manual for Reference

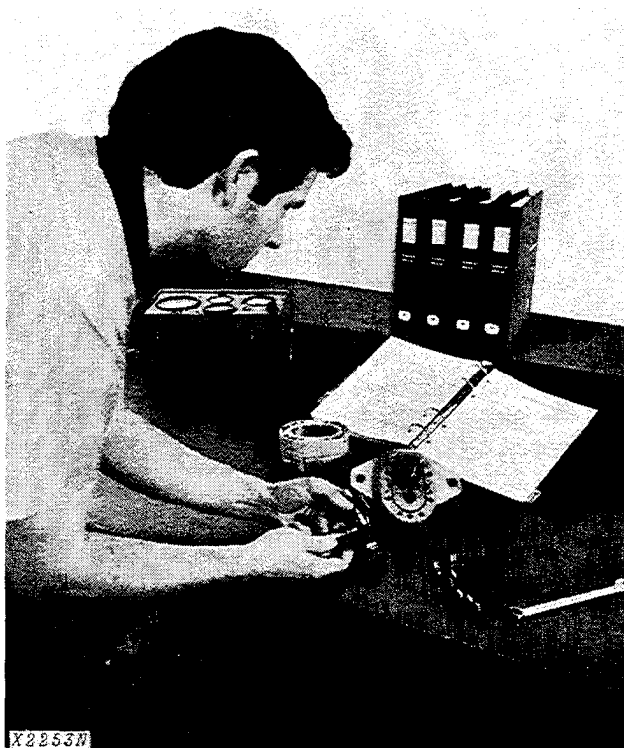

Use Technical Manuals for Actual Service

This technical manual is part of a twin concept of service:

The two kinds of manuals work as a team to give you both the general background and technical details of shop service.

•FOS Manual—for reference

Fundamentals of Service (FOS) Manuals cover basic theory of operation, *fundamentals* of trouble shooting, *general* maintenance, and *basic* types of failures and their causes. FOS Manuals are for training new personnel and for reference by experienced service technicians.



When a service technician should refer to a FOS Manual for more information, a FOS symbol like the one at the left is used in the TM to identify the reference.

•Technical Manuals—for actual service

Technical Manuals are concise service guides for a specific machine. Technical manuals are on-the-job guides containing only the vital information needed by an experienced service technician.

This technical manual was planned and written for you—an experienced service technician. Keep it in a permanent binder in the shop where it is handy. Refer to it whenever in doubt about correct service procedures or specifications.

Some features of this manual:

- Inside front cover - "Table of Contents".
- Section I - Contents, safety information, general specifications and general services.
- Sections 1 through 40 - Removal, repair, testing (components removed), installation, and adjustment.
- Section 90 - Detailed explanation of system operation, diagnosis, visual inspection, testing, and adjustments.
- Specifications grouped and illustrated at the end of each section.

MAINTENANCE WITHOUT ACCIDENT WORK SAFELY



T27999N

 This safety alert symbol is used for important safety messages. When you see this symbol, the possibility of personal injury exists if safety message is not followed.

EVERY EMPLOYER HAS A SAFETY PROGRAM. KNOW WHAT IT IS!

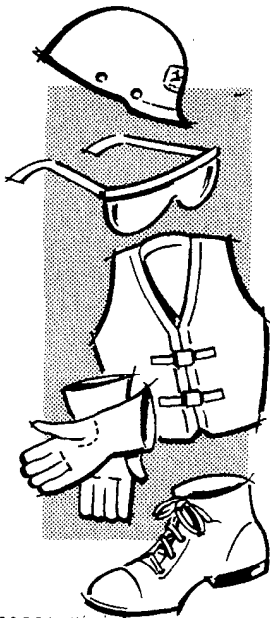

T27501N

Consult your shop supervisor for specific instructions on a job, and the safety equipment required.

For instance, you may need: Hard hat, safety shoes, safety goggles, heavy gloves, reflector vests, ear protectors, respirators.

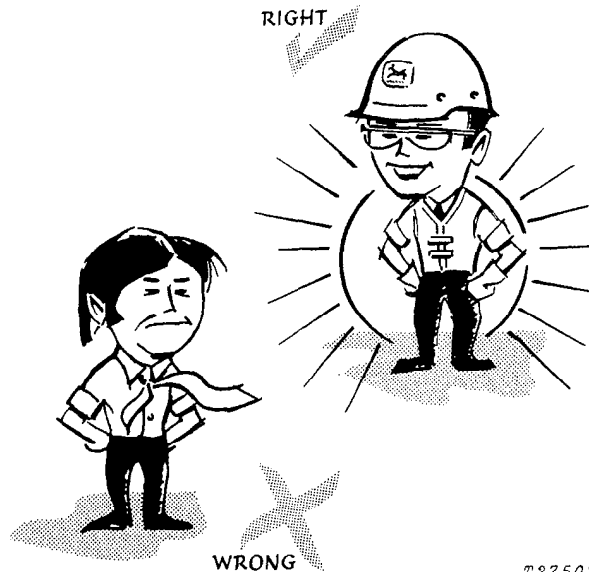

WRONG

T27502N

ALWAYS AVOID loose clothing or any accessory—flopping cuffs, dangling neckties and scarves, or rings and wrist watches—that can catch in moving parts and put you out of work.

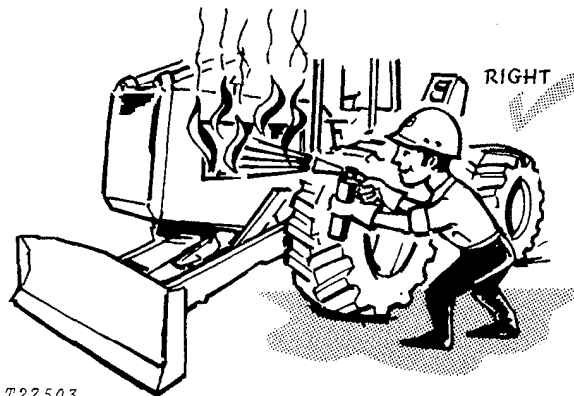

T27503

BE ALERT!

Plan ahead—work safely—avoid accidental damage and injury. If a careless moment does cause an accident or fire, react quickly with the tools and skills at hand—know how to use a first aid kit and a fire extinguisher—and where to get aid and assistance. In an emergency, split-second action is the key to safety.

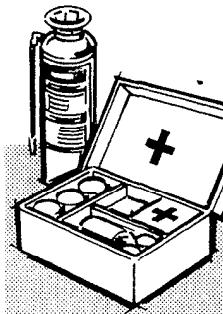

T27504N

MAINTENANCE WITHOUT ACCIDENT

Specific safety procedures should always be observed, whether servicing or making repairs on the skidder. Remember these—in time!—can prevent an injury...or save your life....

AVOID FIRE HAZARDS—

Fuel Is Dangerous!

Don't smoke while refueling.

Don't smoke while handling highly flammable material.

Engine should be shut off when refueling.

Use care in refueling if the engine is hot.

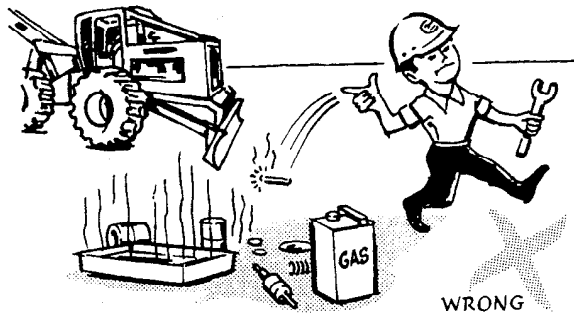

T33257N

Don't use open pans of gasoline or diesel fuel for cleaning parts. Good commercial, nonflammable solvents are preferred.

Battery Gas Is Highly Flammable!

Provide adequate ventilation when charging batteries.

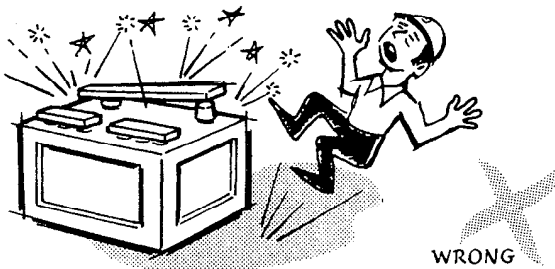

T27506N

Don't check battery charge by placing metal objects across the posts.

Don't allow sparks or open flame near batteries.

Don't smoke near battery.

Flame Is Not a Flashlight!

Never check fuel, battery electrolyte or coolant levels with an open flame.

Never use an open flame to look for leaks anywhere on the equipment.

Never use an open flame as a light anywhere on or around the equipment.

KNOW WHERE FIRE EXTINGUISHERS ARE KEPT!

UNDER ALL MAINTENANCE CONDITIONS—

Do not perform any work on the skidder unless authorized to do so. Then be sure you understand the services required. Follow recommended procedures.

Never service the equipment while it is being operated.

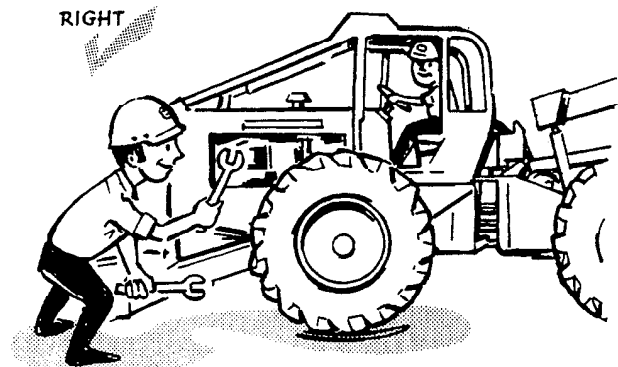

T33258N

Avoid working on equipment with the engine running. If it is necessary to make checks with the engine running, **ALWAYS USE TWO SERVICE TECHNICIANS**—one, the operator, at the controls, the other checking in view of the operator. Also, put the transmission in neutral, set the brake, and apply any safety locks provided. **KEEP HANDS AWAY FROM MOVING PARTS.**



T27508N

MAINTENANCE WITHOUT ACCIDENT

Before servicing, adjusting, or repairing skidders which have attachments such as blades, grapple tongs, etc.—**LOWER** attachments to the ground—or, if necessary to raise them for access to certain parts, **SECURELY SUPPORT** by external means. **DO NOT** rely on controls to support or position attachments for maintenance.

Never allow **ANYONE** to walk under equipment that is raised and not properly blocked.

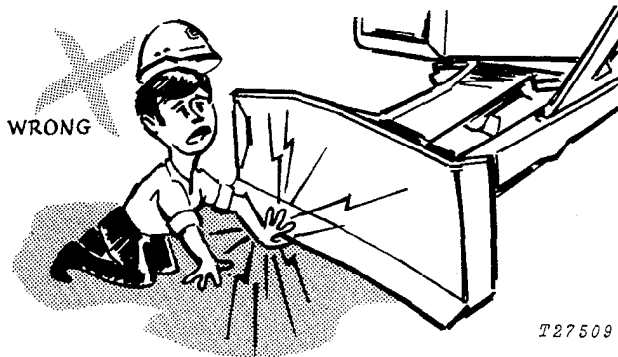

Avoid working directly under raised and blocked equipment unless absolutely necessary.

If the skidder is on an incline, block it securely.

Use hoisting equipment for lifting heavy parts. **TAKE CARE! WATCH OUT FOR OTHER PEOPLE IN THE VICINITY.**

Use extreme caution in removing radiator caps, drain plugs, grease fittings, or hydraulic pressure caps.

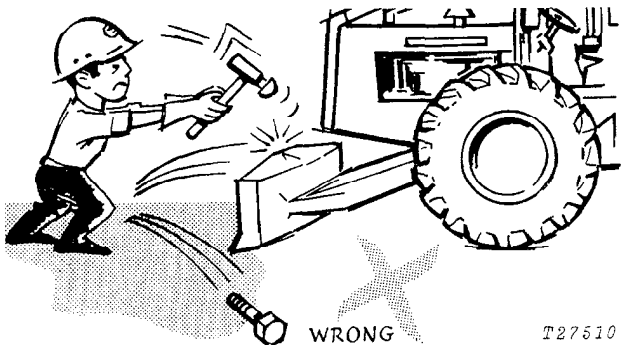

Wear safety glasses when drilling, grinding, or hammering metal.

Make sure the maintenance area is adequately vented.

Keep maintenance area **CLEAN AND DRY**. Oily and wet floors are slippery; greasy rags are a fire hazard; wet spots are dangerous when working with electrical equipment.

Store starting aids in a cool and well-ventilated place, out of the reach of unauthorized personnel.

SERVICING PRECAUTIONS

Stop the engine before cleaning or lubricating the skidder.

Lower blade and grapple to the ground *carefully*.

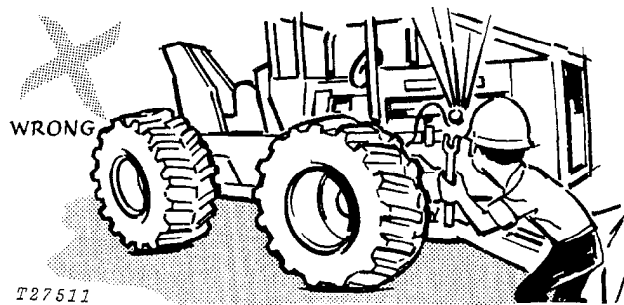

Engine coolant gets hot! Don't remove the radiator cap until coolant temperature is below the boiling point. Then turn cap slightly to relieve pressure before removing.

Exhaust gases are dangerous! Periodically check exhaust system for excessive leakage.

Don't forget a hydraulic system may be pressurized! To relieve system pressure, stop engine, lower blade and boom and operate blade, boom or grapple controls until system fails to respond.

When checking hydraulic pressure, be sure to use the correct test gauge for the pressure in the particular system.

The skidder is equipped with a brake accumulator—recharge by using only dry nitrogen. To discharge brake accumulator apply the brake pedal about 30 times.

MAINTENANCE WITHOUT ACCIDENT

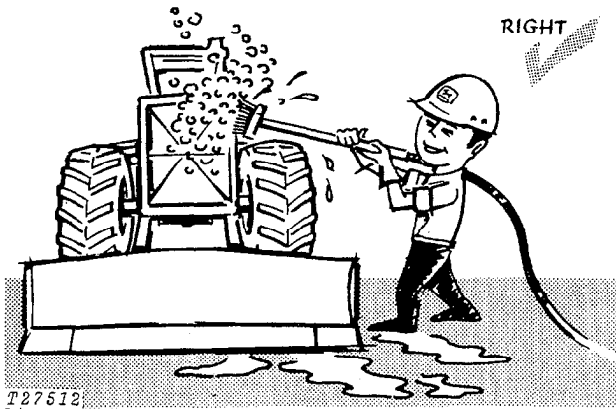

Keep ALL components free of dirt and oil. This attention will minimize fire hazards and facilitate spotting of loose or defective parts.

When preparing engine for storage, remember that inhibitor is volatile and therefore dangerous. Seal and tape openings after adding inhibitor. Keep container tightly closed when not in use.

ADJUSTING PRECAUTIONS

...for Operating Adjustments

Keep clutch and brake control units properly adjusted at all times. Before making adjustments, stop engine.

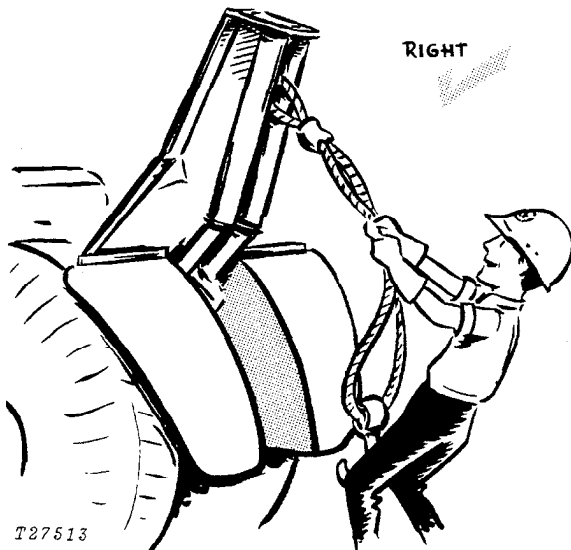

Always wear gloves when handling cable.

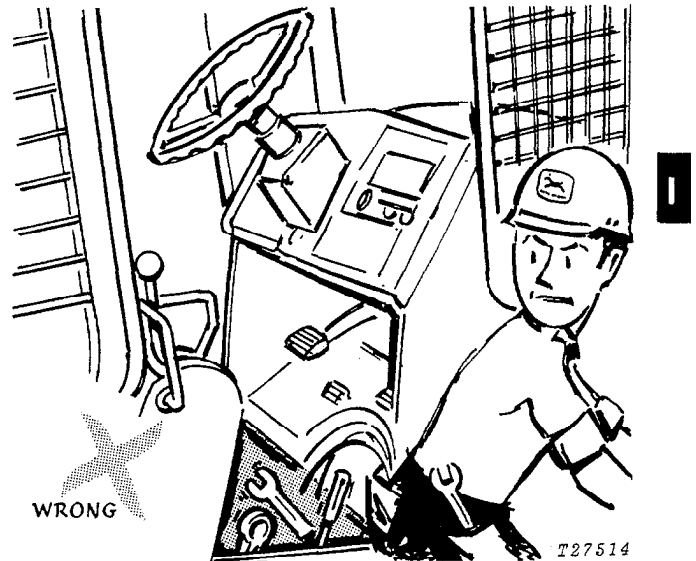

Before removing any housing covers, stop engine. Take all objects from your pockets which could fall into the opened housings. Don't let adjusting wrenches fall into opened housings.

...for Maintenance Adjustments

Don't attempt to check belt tension while the engine is running.

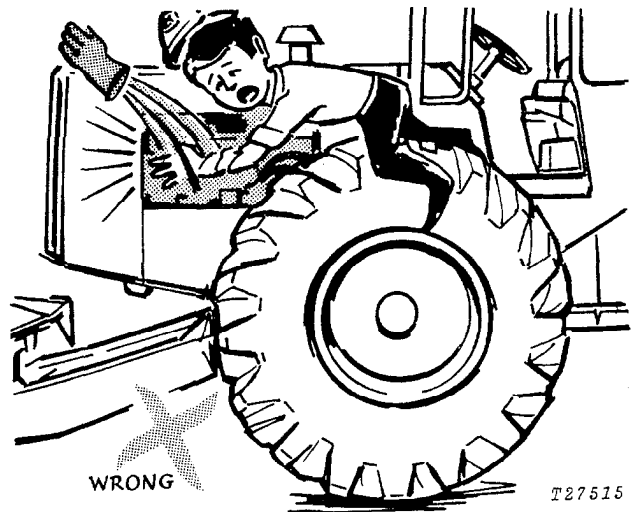

Don't adjust the fuel system while the machine is in motion.

MAINTENANCE WITHOUT ACCIDENT

PRECAUTIONS DURING REPAIR

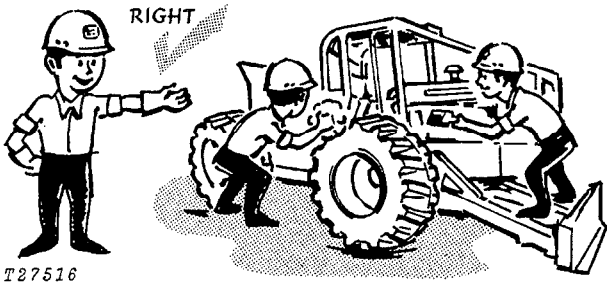

Before repairing the electrical system, or performing a major overhaul, make sure the batteries are disconnected.

When changing cutting edges on blade—
Stop the engine and securely block the blade.

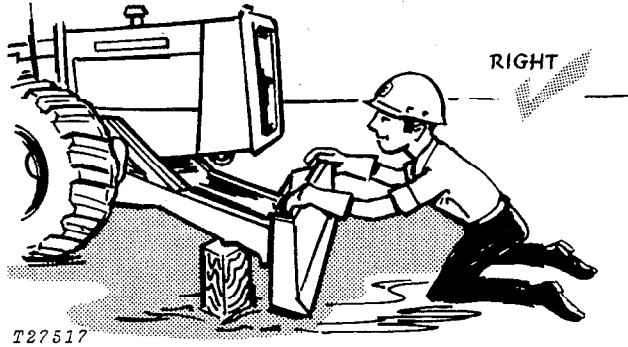

Never let your bare hands come in contact with sharp edges. WEAR GLOVES.

MAINTENANCE WITHOUT ACCIDENT

KNOW EQUIPMENT IS READY!

Check guards, canopies, safety bars—all protective devices installed on the skidder. Every one should be in place and secure.

CHECK IT OUT!

- GUARDS
- CANOPIES
- SHIELDS
- PROTECTIVE DEVICES
- ROLL-OVER PROTECTIVE STRUCTURES
- SEAT BELTS
- FIRE EXTINGUISHER
- FIRE SUPPRESSION SYSTEM, ETC.

RIGHT

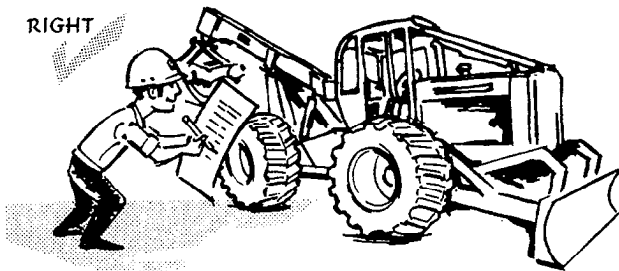

T33262N

Carefully inspect equipment for visual defects—leaks in fuel, lubrication, and hydraulic systems. Do not search for pressurized fluid leaks with your hands. Use cardboard or wood to search for leaks.

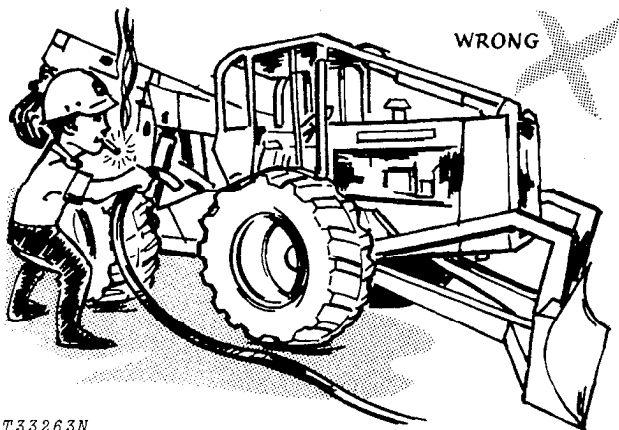

T33263N

Check levels of fuel, coolant, hydraulic fluid, and lubricating oil. If fuel must be added—**FIRST, PUT OUT THAT CIGARET.**

Check and secure all caps and filler plugs for fuel, oils, radiator, etc.

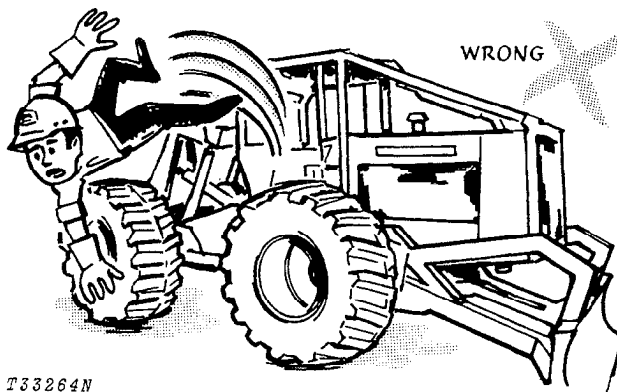

T33264N

Be sure to clean any oil, grease or mud accumulation from floor of operator's compartment, stepping points, and grab rails to minimize the danger of slipping.

In freezing weather beware of snow or ice deposits on stepping points, grab rails, and floor.

Remove loose bolts, tools, or other objects from floor of operator's compartment.

Although it is impractical to try to cover every possible maintenance situation, the safety precautions recommended here should serve to develop and promote safe maintenance procedures.

The information contained in this manual is not intended to replace safety codes, insurance requirements, federal, state, and local laws, rules and regulations. In particular, your service area or jobsite activities may be subject to state safety rules and/or federal regulation under the Occupational Safety and Health Act (OSHA). Familiarize yourself with all regulations applicable to your situation in order to avoid possible safety violations.

Illustrations and copy reproduced in part by permission of Construction Industry Manufacturers' Association (CIMA).

Group III GENERAL SPECIFICATIONS

SKIDDER

(Specifications and design are subject to change without notice. Whenever applicable, specifications are in accordance with ICED and SAE Standards. Except where otherwise noted, these specifications are based on a unit equipped with 23.1-26, 10-ply-rating logging tires and standard equipment).

Power (@ 2200 engine rpm):	SAE	DIN
Gross	96 hp (71.5 kW*)	
Net	90 hp (67.1 kW)	91 PS

Net engine flywheel power is for an engine equipped with fan, air cleaner, water pump, lubricating oil pump, alternator and muffler. The gross engine power is without fan. Flywheel power ratings are under SAE standard conditions of 500-ft. altitude and 85° F. temperature, and DIN 70 020 conditions (non-corrected). No derating is required up to 10,000 feet (3000 m) altitude.

*In the international system of units (SI) power is expressed in kilowatts (kW).

Engine:

John Deere turbocharged diesel, 4-cylinder, 4-stroke cycle

Bore and stroke 4.19x5 in. (106x127 mm)
Piston displacement 276 cu. in. (4 523 cm³)
Compression ratio 16.7 to 1
Maximum torque @ 1400 rpm ... 270 lb-ft (366 Nm)
(37.32 kg-m)

NACC or AMA (U.S. Tax) horsepower 28
Lubrication Pressure system with full-flow filter
Cooling Pressurized with thermostat
and fixed bypass

Fan Blower
Air cleaner with restriction indicator Dry
Electrical system 12-volt with alternator
Batteries (2) Reserve capacity:
170 minutes

Differentials:

Front and rear Full differentials
with hydraulic lock

Engine Clutch Disconnect:

Hand-operated, spring-loaded, dry-disk. Single plate, 12 in. (305 mm).

Transmission:

Power Shift with planetary gears, hydraulically actuated wet-disk clutches and brakes; provides 8 speeds forward—4 reverse. Controlled by single lever on console.

Travel Speeds (2200 engine rpm, no tire slip):

Forward: 1.7 mph (2.7 km/h) to 17.9 mph (28.8 km/h)
Reverse: 2.0 mph (3.2 km/h) to 5.8 mph (9.3 km/h)

Drive Axles:

Four-wheel drive with inboard planetary gears on all axles.

Front axle oscillates 15 degrees above and below horizontal. 20 in. (508 mm) total travel at tire center line.

Brakes:

Hydraulic power actuated, dual controlled disks on 4 wheels, lockable for winching. Hand-operated mechanical brake for parking and emergency stop.

Power Steering:

Articulated frame hydraulically actuated by dual cylinders.

Turning radius 16 ft. 4 in. (4.97 m)
Turning clearance 34 ft. 5 in. (10.49 m)

Hydraulic System:

Closed-center constant pressure. Variable-displacement pump driven from crankshaft... 25 gpm (95 L/min) 2000 psi (137.9 bar) (140.6 kg/cm²) @ 2200 engine rpm. Full flow filtration. Oil cooler integral with radiator.

Tires:

- 18.4-34, 16-ply-rating, kevlar-ply, LS-2*
- 23.1-26, 16-ply-rating, kevlar-ply, LS-2*
- 18.4-26, 10-ply-rating, logging, LS2
- 18.4-34, 10-ply-rating, steel-ply, LS2
- 23.1-26, 10-ply-rating, steel-ply, LS2
- 28.1-26, 10-ply-rating, steel-ply, LS3
- 28.1-26, 14-ply-rating, steel-ply, LS2

*Canada only

Capacities:	U.S.	Liters
Fuel tank	42 gal.	159.0
Cooling system	8 gal.	30.3
Engine lubrication, including filter	15 qt.	14.2
Transmission and hydraulic system ..	9 gal.	34.1
Front differential	4.5 gal.	17.0
Rear differential	4.5 gal.	17.0
Winch	2.5 gal.	9.5

SAE Operating Weight 16,675 lb. (7 564 kg)

Winch:

Cable capacities*:

- 1/2-in. (12.7 mm) cable 217 ft. (66.1 m)
- 5/8-in. (15.8 mm) cable 142 ft. (43.3 m)
- 3/4-in. (19.1 mm) cable 100 ft. (30.5 m)

*Calculated: No allowance made for loose or uneven spooling.

Line pull (maximum engine torque):

- Bare drum 30,541 lb. (136.89 kN) (13 853 kg)
- Full drum 18,794 lb. (84.24 kN) (8 525 kg)

Line speed (2200 rpm):

- Bare drum 115 fpm (35.1 m/min)
- Full drum 187 fpm (56.9 m/min)

Blade: Hydraulic control

- Width 6 ft. 11 in. (2.11 m)
- Height (ends) 1 ft. 8 in. (508 mm)
- Height (center) 2 ft. 3 in. (686 mm)
- Max. lift above ground level 4 ft. 4 in. (1.31 m)
- Max. drop below ground level 9 in. (229 mm)

Arch:

- Horizontal roller 6 in. (152 mm) dia.
- Vertical rollers (through-hardened steel)
..... 4.5 in. (114 mm) dia.
- Working height (top of horizontal roller to ground):
Settings: Lower—6 ft. (1.83 m)
Upper—6 ft. 5 in. (1.95 m)

Additional Standard Equipment:

- Muffler
- Fuel gauge
- Engine oil pressure gauge
- Alternator charge warning light
- Water temperature gauge
- Transmission oil temperature gauge
- Transmission oil pressure warning light
- Parking brake warning light and buzzer
- Transistorized voltage regulator
- Electric hour meter
- Key switch with push button safety start
- Horn
- Fire extinguisher
- Flanged axles
- John Deere winch
- Cold weather starting aid
- Heavy duty starter
- Log arch with adjustable rollers
- Engine side shields
- Deluxe seat with suspension
- Cigar lighter
- Foot throttle
- Hand throttle
- Lights
- Front blade
- Integral log bumper
- Roll-over protective structure (ROPS) with canopy,
seat belt, brush screens, and limb risers
- Vandal protection
- Reinforced bottom guards

Special Equipment:

- Wheel weights
- Engine coolant heater
- Steering accumulator
- Cab with heater and noise treatment
- Windshield with wiper
- 3 in. (76 mm) seat belt
- Automatic fire suppression system

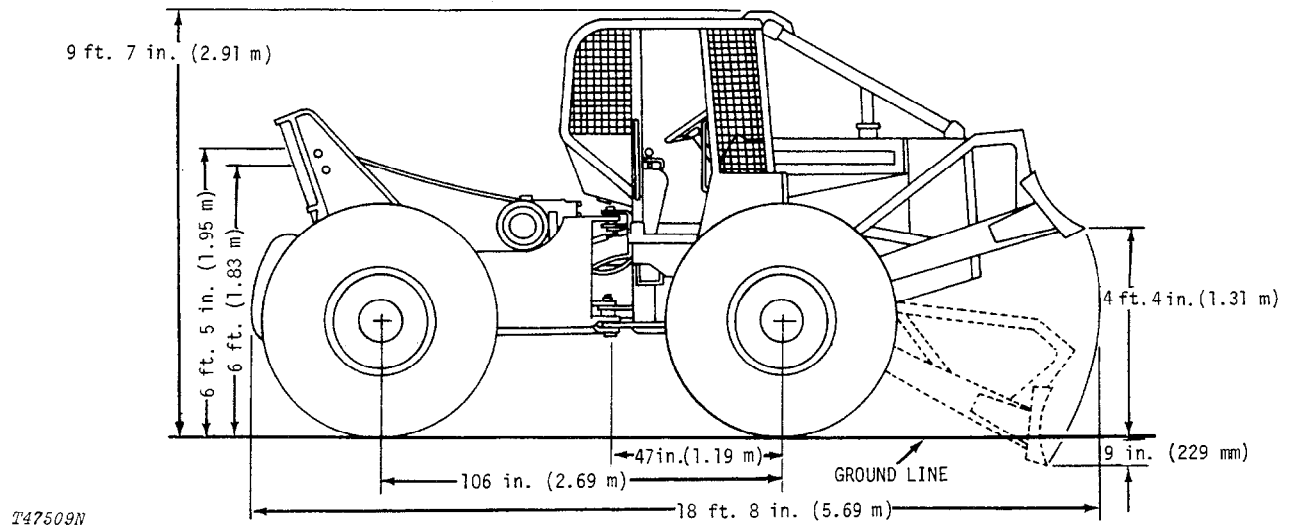

Side view dimensions are for skidder equipped with 23.1-26 tires and adjustable arch, and regular bumper in upper position.

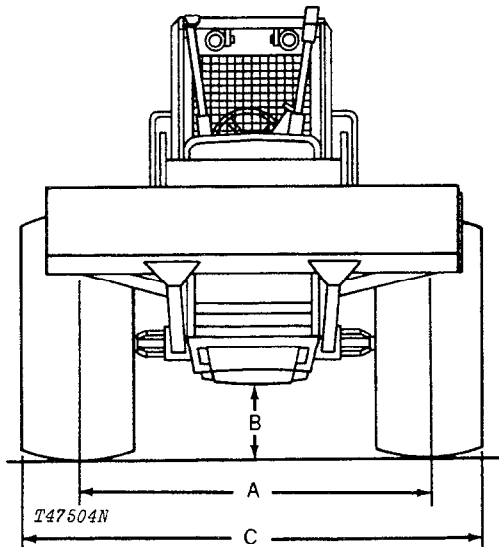

TIRE SIZE	A WHEEL TREAD	B GROUND CLEARANCE	C OVERALL WIDTH
18.4-26	76 in. (1.93 m)	1 ft. 8.5 in. (521 mm)	7 ft. 10.4 in. (2.40 m)
18.4-34	76.5 in. (1.94 m)	1 ft. 10 in. (559 mm)	7 ft. 11.4 in. (2.42 m)
23.1-26	80.8 in. (2.05 m)	1 ft. 9 in. (533 mm)	8 ft. 7.9 in. (2.64 m)
28.1-26	85.4 in. (2.17 m)	1 ft. 9.5 in. (546 mm)	9 ft. 5.5 in. (2.78 m)

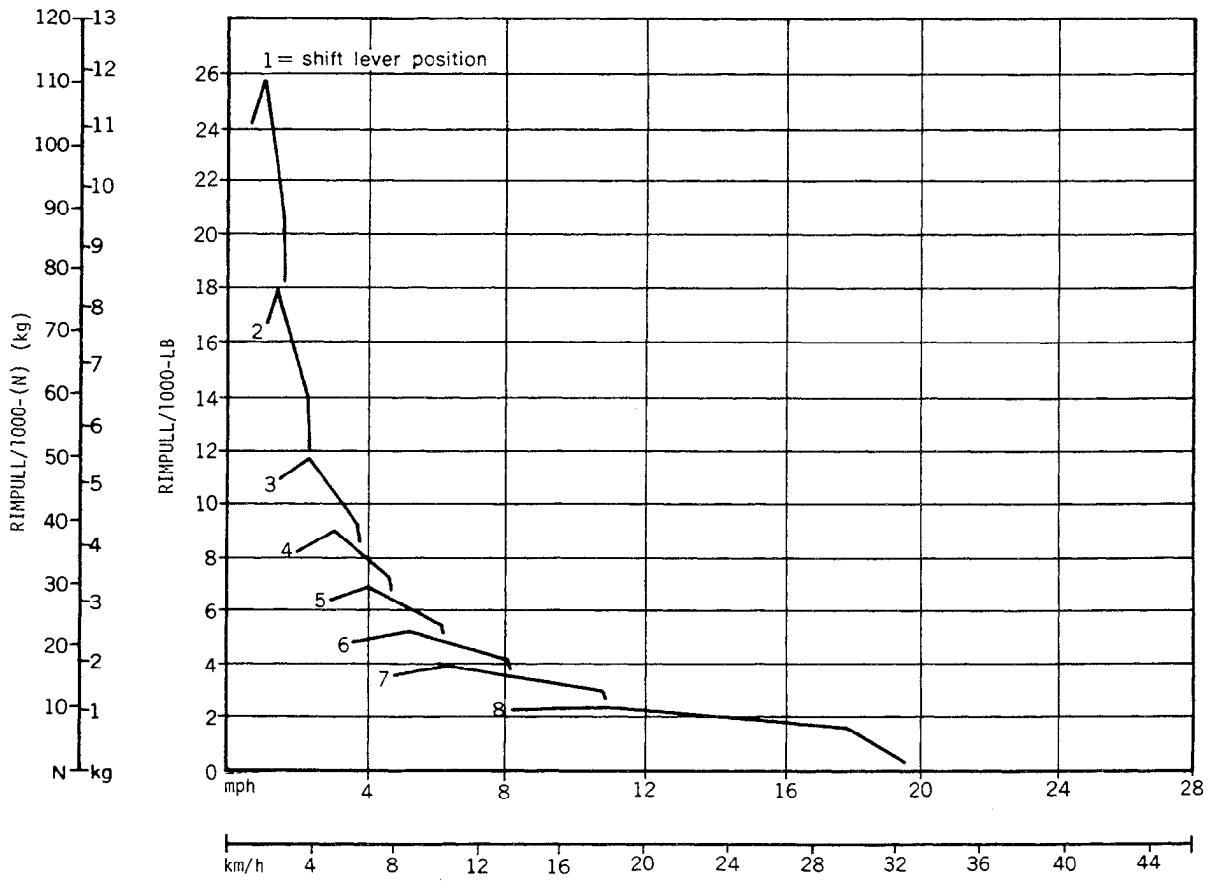

T47510N

GRAPPLE SKIDDER

(Specifications and design are subject to change without notice. Wherever applicable, specifications are in accordance with ICED and SAE Standards. Except where otherwise noted, these specifications are based on a unit equipped with 23.1-26, 10-ply-rating logging tires and standard equipment.)

Power @ (2200 engine rpm):	SAE	DIN
Gross	96 hp (71.5 kW*)	
Net	90 hp (67.1 kW)	91.3 PS

Net engine flywheel power is for an engine equipped with fan, air cleaner, water pump, lubricating oil pump, fuel pump, alternator and muffler. The gross engine power is without fan. Flywheel power ratings are under SAE standard conditions of 500-ft. altitude and 85°F temperature, and DIN 70 020 conditions (non-corrected). No derating is required up to 10,000 feet (3000 m) altitude.

*In the international system of units (SI) power is expressed in kilowatts (kW).

Engine:

- John Deere turbocharged diesel 4-cylinder, 4-stroke cycle
- Bore and stroke 4.19x5 in. (106x127 mm)
- Piston displacement 276 cu. in. (4523 cm³)
- Compression ratio 16.7 to 1
- Maximum torque @ 1400 rpm ... 270 lb-ft (366 Nm) (37.32 kg-m)
- NACC or AMA (U.S. Tax) horsepower 28
- Lubrication Pressure system with full-flow filter
- Cooling Pressurized with thermostat and fixed bypass
- Fan Blower
- Air cleaner with restriction indicator Dry
- Electrical system 12-volt with alternator
- Batteries (2) Reserve capacity: 170 minutes

Differentials:

Front and rear .. Full differentials with hydraulic lock

Engine Clutch Disconnect:

Hand-operated, spring-loaded, dry-disk. Single plate, 12 in. (305 mm).

Transmission:

Power Shift with planetary gears, hydraulically actuated wet-disk clutches and brakes; provides 8 speeds forward—4 reverse. Controlled by single lever on console.

Travel Speeds (2200 engine rpm, no tire slip):

Forward: 1.7 mph (2.7 km/h) to 17.9 mph (28.5 km/h)
Reverse: 2.0 mph (3.2 km/h) to 5.8 mph (9.3 km/h)

Drive Axles:

Four-wheel drive with inboard planetary gears on all axles. Front axle oscillates 15 degrees above and below horizontal. 20 in. (508 mm) total travel at tire center line.

Brakes:

Hydraulic power actuated, dual controlled disks on 4 wheels, lockable for winching. Hand-operated mechanical brake for parking and emergency stop.

Power Steering:

Articulated frame hydraulically actuated by dual cylinders.
Turning radius 16 ft. 4 in. (4.97 m)
Turning clearance 34 ft. 5 in. (10.49 m)

Hydraulic System:

Closed-center constant pressure. Variable-displacement pump driven from crankshaft... 33.5 gpm (126.5 L/min) 2000 psi (137.9 bar) (140.6 kg/cm²) @ 2200 engine rpm. Full flow filtration. Oil cooler integral with radiator.

Hydraulic Cylinders: Bore Stroke

Lift (2)	4.0 in. (102 mm)	30 in. (762 mm)
Grapple (1)	5.25 in. (133 mm)	17 in. (432 mm)
Cylinder rods	Ground, heat-treated, chrome-plated, polished	
Lift cylinder rods	2-in. (51 mm) dia.	
Grapple cylinder rod	2.25 in. (57 mm) dia.	

Tires:

- 23.1-26, 16-ply-rating, kevlar-ply, LS2*
- 18.4-34, 10-ply-rating, steel-ply, LS2
- 23.1-26, 10-ply-rating, steel-ply, LS2
- 28.1-26, 10-ply-rating, steel-ply, LS3
- 28.1-26, 14-ply-rating, steel-ply, LS2

*Canada only

Capacities:	U.S.	Liters
Fuel tank	42 gal.	159.0
Cooling system	8 gal.	30.3
Engine lubrication, including filter ...	15 qt.	14.2
Transmission and hydraulic system .	9 gal.	34.1
Front differential	4.5 gal.	17.0
Rear differential	4.5 gal.	17.0
Winch	2.5 gal.	9.5

SAE Operating Weight 18,675 lb. (8 471 kg)

Winch:

Cable capacities*:

- 1/2-in. (12.7 mm) cable 217 ft. (66.1 m)
- 5/8-in. (15.8 mm) cable 142 ft. (43.3 m)
- 3/4-in. (19.1 mm) cable 100 ft. (30.5 m)

*Calculated: No allowance made for loose or uneven spooling.

Line pull (maximum engine torque):

- Bare drum 30,541 lb. (136.89 kN) (13 853 kg)
- Full drum 18,794 lb. (84.24 kN) (8 525 kg)

Line speed (2200 rpm):

- Bare drum 115 fpm (35.1 m/min)
- Full drum 187 fpm (56.9 m/min)

Blade: Hydraulic control

- Width 6 ft. 11 in. (2.11 m)
- Height (ends) 1 ft. 8 in. (508 mm)
- Height (center) 2 ft. 3 in. (686 mm)
- Max. lift above ground level 4 ft. 4 in. (1.31 m)
- Max. drop below ground level 9 in. (229 mm)

Additional Standard Equipment:

- Muffler
- Fuel gauge
- Engine oil pressure gauge
- Alternator warning light
- Water temperature gauge
- Transmission oil temperature gauge
- Transmission oil pressure warning light
- Parking brake warning light and buzzer
- Transistorized voltage regulator
- Electric hour meter
- Key switch with pushbutton safety start
- Horn
- Fire extinguisher
- Flanged axles
- John Deere winch
- Cold weather starting aid
- Heavy duty starter
- Hinge lock bar
- Engine side shields
- Deluxe seat with suspension
- Cigar lighter
- Foot throttle
- Hand throttle
- Lights
- Front blade
- Roll-over protective structure (ROPS) with canopy, seat belt, brush screens, and limb risers
- Vandal protection
- Reinforced bottom guard

Special Equipment:

- Wheel weights
- Engine coolant heater
- Steering accumulator
- Cab with heater and noise treatment
- Windshield with wiper
- 3 in. (76 mm) seat belt
- Fairlead for winch
- Automatic fire suppression system

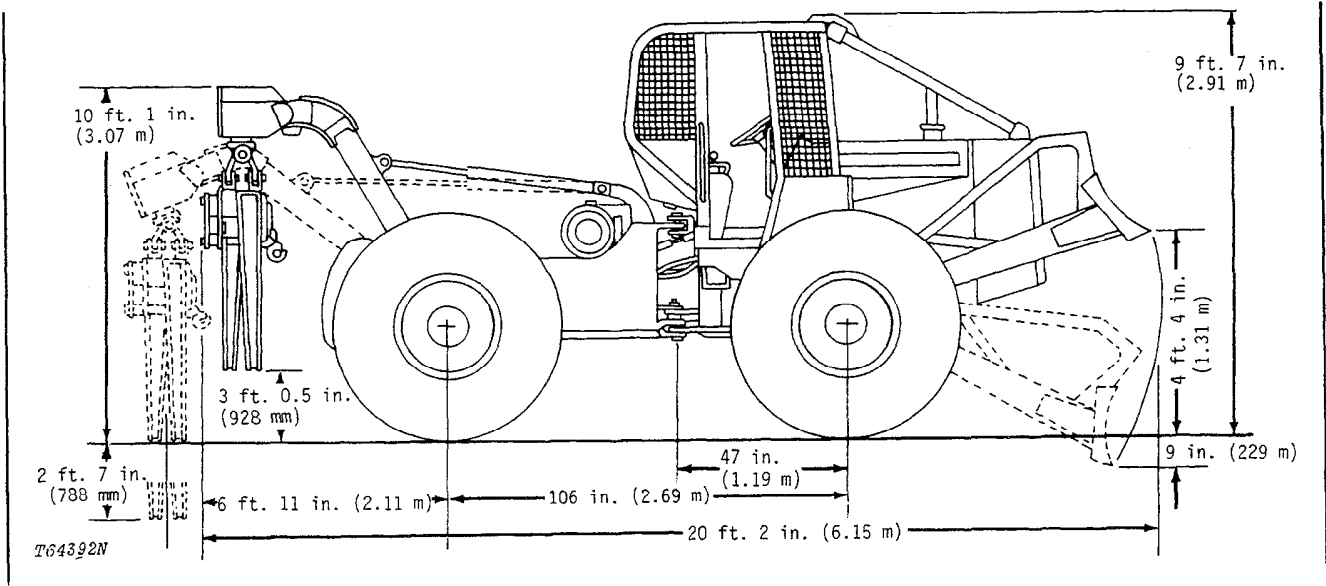

Side view dimensions are for skidder equipped with 23.1-26 tires, grapple open.

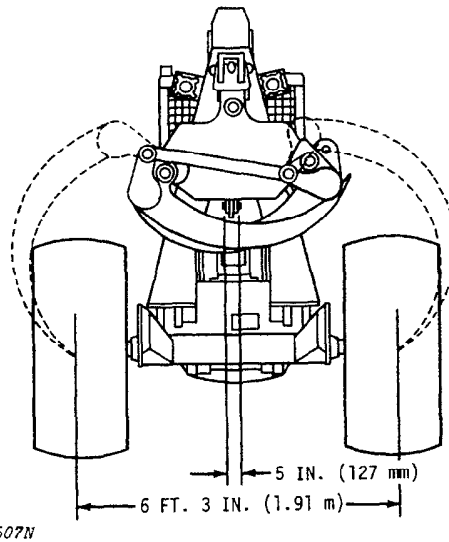
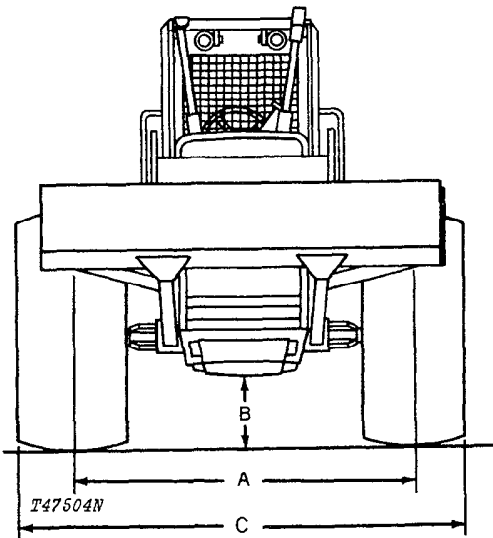

TIRE SIZE	A WHEEL TREAD	B GROUND CLEARANCE	C OVERALL WIDTH
18.4-34	76.5 in. (1.94 m)	1 ft. 10 in. (559 mm)	7 ft. 11.4 in. (2.42 m)
23.1-26	80.8 in. (2.05 m)	1 ft. 9 in. (533 mm)	8 ft. 7.9 in. (2.69 m)
28.1-26	85.4 in. (2.17 m)	1 ft. 9.5 in. (546 mm)	9 ft. 5.5 in. (2.78 m)

DIMENSIONS NOT SHOWN:

Tip closure force 6300 lb. (28.24 kN) (2 858 kg)
 Enclosure area, tips meeting 8 sq. ft. (0.74 m²)

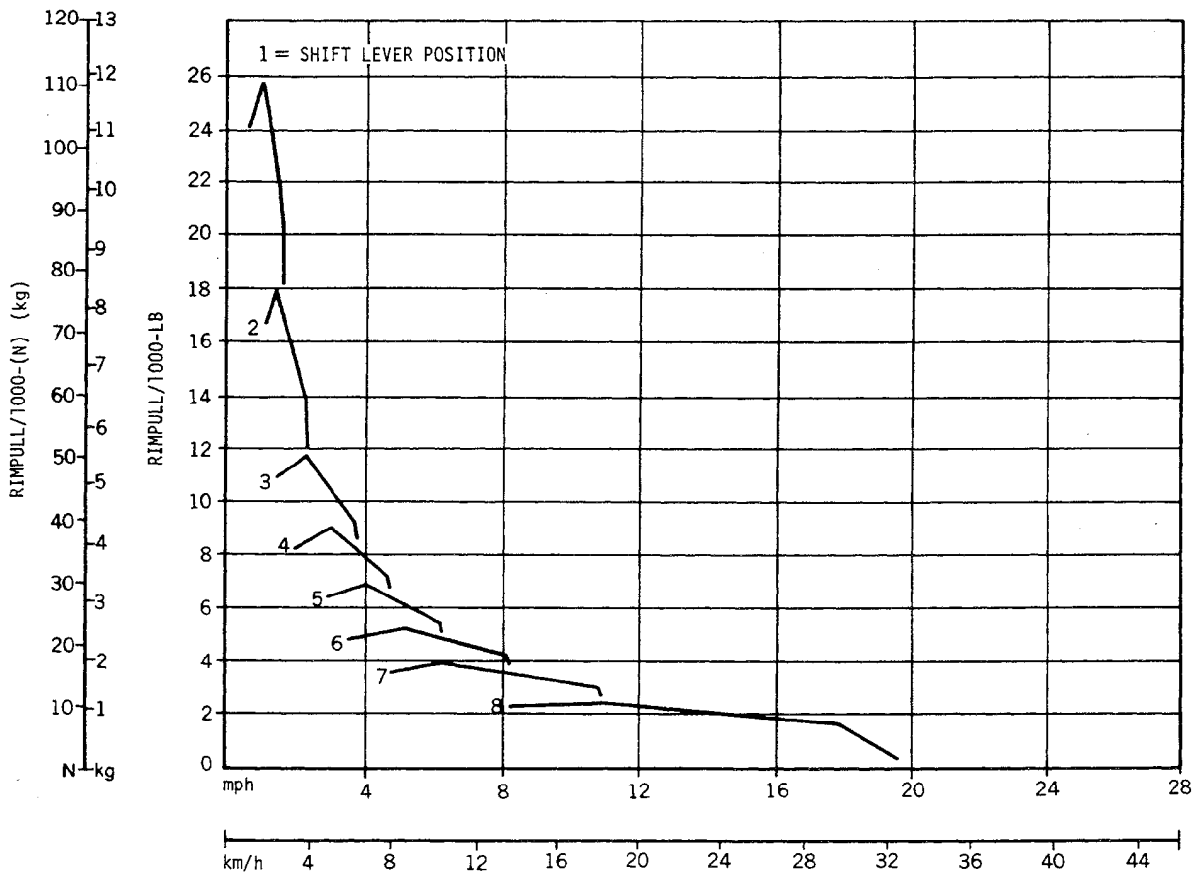

T47512N

Group IV PREDELIVERY, DELIVERY, AND AFTER-SALE SERVICES

TEMPORARY STORAGE

After receiving your skidder from the factory and before putting the skidder into temporary storage, perform the following checks.

1. Check battery electrolyte level and charge the batteries, if necessary.
2. Check coolant level in the radiator. The coolant should be maintained at a level midway between the radiator core and filler neck.
3. Check crankcase oil level. Oil should be at top mark of dipstick after machine has been shut down for 10 minutes.
4. Relieve hydraulic pressure by stopping engine, lowering boom and blade, and operating control levers until system fails to respond.

PREDELIVERY SERVICE

Because of the shipping factors involved, plus extra finishing touches that are necessary to promote customer satisfaction, proper predelivery service is of prime importance to the dealer and the customer.

If adjustments are required, procedures are found in the After-Sale section.

Use the following list when preparing a skidder for delivery to the customer.

1. Air Cleaner

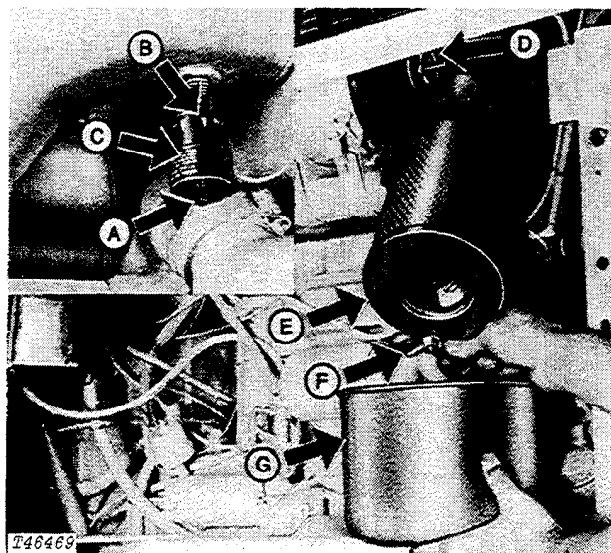

- | | |
|-------------------------|---------------------|
| A—Reset Button | E—Primary Element |
| B—Restriction Indicator | F—Wing Nut |
| C—Red Signal | G—Air Cleaner Cover |
| D—Safety Element | |

Fig. 1—Air Cleaner Components

Check air filter restriction indicator. If red signal locks in full view, look for restriction or blockage in air intake system.

Air cleaner elements checked	Yes	No
Restriction in system	Yes	No

2. Radiator

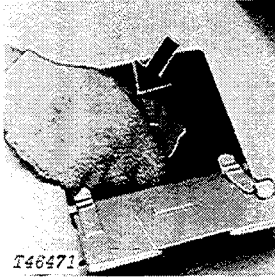

Fig. 2-Radiator Filler Cap

CAUTION: Do not remove radiator filler cap until coolant temperature is below its boiling point. Then loosen cap slowly to the stop to relieve any excess pressure before removing cap completely.

Check coolant level in radiator. Coolant should be maintained at a level midway between the radiator core and filler neck.

The antifreeze-water ratio is approximately 50 percent each. This protects to at least -34°F (-37°C).

Radiator coolant level checked Yes No

3. Batteries

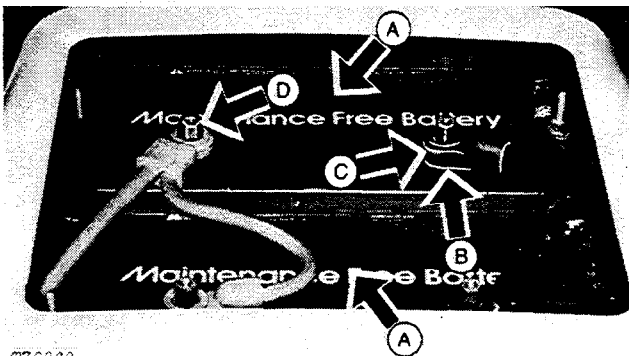

270868
 A—Batteries
 B—Stud Pad
 C—Eyelet
 D—Nut

Fig. 3-Batteries

Check terminals and connections.

If terminals are corroded, clean them with a stiff brush.

The cable connector seal should not be pinched between the stud pad and eyelet.

Check torque on four nuts. Torque should be 15 lb-ft (20 N·m).

If needed, clean batteries with a damp cloth.

Litho in U.S.A.

Punch date code on battery.

Water added Yes No
 Battery connections checked Yes No

4. Tire Pressure

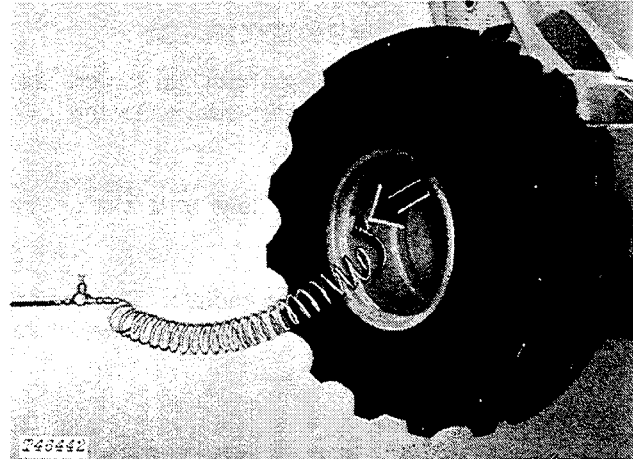

Fig. 4-Correct Tire Filling Procedure

Check air pressure in the tires with an accurate gauge having 1 psi (0.05 bar) (0.05 kg/cm²) graduations.

Tire Size	Type	Ply Rating	Inflation Pressure
18.4-26	LS-2	10	25 psi (1.7 bar) (1.7 kg/cm ²)*
18.4-34	LS-2	10	25 psi (1.7 bar) (1.7 kg/cm ²)
23.1-26	LS-2	10	20 psi (1.4 bar) (1.4 kg/cm ²)**
28.1-26	LS-3	10	15 psi (1.0 bar) (1.0 kg/cm ²)
23.1-26	LS-2	16	20 psi (1.4 bar) (1.4 kg/cm ²)**
18.4-34	LS-2	16	25 psi (1.7 bar) (1.7 kg/cm ²)****

*Skidder only.

**Cannot be used with wheel weights.

***Canada only (Skidder, Grapple Skidder) (Kevlar-Ply)

****Canada only (Skidder) (Kevlar-Ply)

CAUTION: Failure to follow proper procedures when mounting a tire on a wheel or rim can produce an explosion which may result in serious bodily injury. DO NOT attempt to mount a tire unless you have the proper equipment and experience to perform the job safely.

Detailed tire mounting instructions, including necessary safety precautions, are contained in John Deere Fundamentals of Service (FOS) Manual 55, Tires and Tracks.

Tire pressure checked Yes No

**Thank you very much for
your reading. Please Click
Here. Then Get COMPLETE
MANUAL. NO WAITING**



NOTE:

**If there is no response to
click on the link above,
please download the PDF
document first and then
click on it.**

5. Crankcase Oil Level

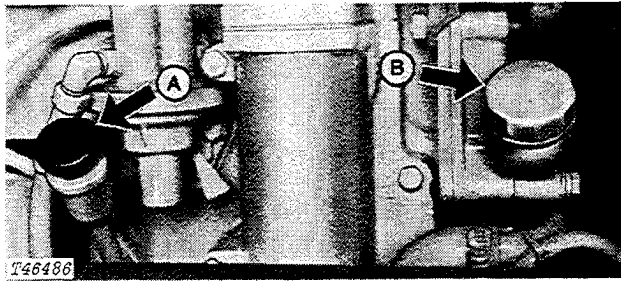

A—Dipstick

B—Oil Filler Cap

Fig. 5-Crankcase Oil Level

Check crankcase oil level with skidder on level ground. (Allow a minimum of 10 minutes for the oil to drain down before checking.) If oil level is at or below bottom mark on dipstick, add sufficient oil of the proper viscosity and type specified on page I-V-3 to bring oil level to between marks on dipstick: Do not operate engine with oil level below the bottom mark.

Crankcase oil level checked	Yes	No
Oil added, if any	_____qts (L)	

6. Transmission - Hydraulic System Oil Level

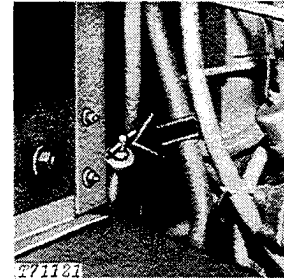

Fig. 6-Dipstick and Oil Filler Cap

Run engine two to three minutes.

Check oil level with:

- 1 - Skidder on level ground.
- 2 - Blade lowered (with engine running).
- 3 - Grapple tongs closed and lowered (with engine running).
- 4 - Engine stopped.

Allow a minimum of 5 minutes after shutdown before checking oil.

Oil level should be to top mark on dipstick while resting on filler tube. If low, add oil specified on page I-V-3.

Oil level checked	Yes	No
Oil added, if any	_____qts (L)	

7. Winch Housing Oil Level

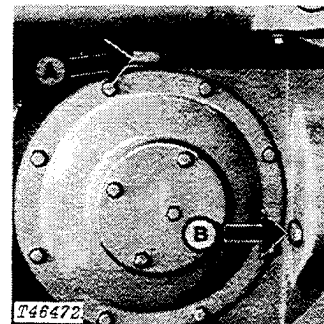

A—Filler Plug

B—Oil Level Plug

Fig. 7-Winch Housing Oil Level

Check oil level by removing oil level plug.

If low, remove filler plug and add oil specified on page I-V-3. Oil should be to level of oil level plug.

Winch oil level checked	Yes	No
Oil added, if any	_____qts (L)	

8. Fuel Gauge

Check fuel gauge. Turn on key switch and check for movement of indicator on gauge. If no movement is noted, add a small amount of fuel and repeat procedure.

If no indicator movement is noted, gauge is not functioning.

Fuel gauge functional Yes No

9. Grease Fittings

The skidder was checked and lubricated before it left the factory. However, to insure customer satisfaction, check each grease fitting point shown in the following pages. Lubricate with several strokes of John Deere Multi-Purpose Grease, if necessary.

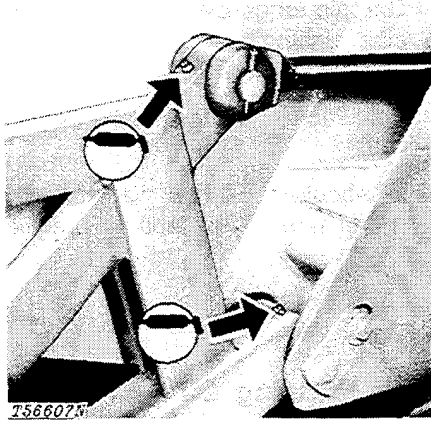

Fig. 8-Stacking Blade and Cylinder Pivots (4 points)

Lubricant required Yes No

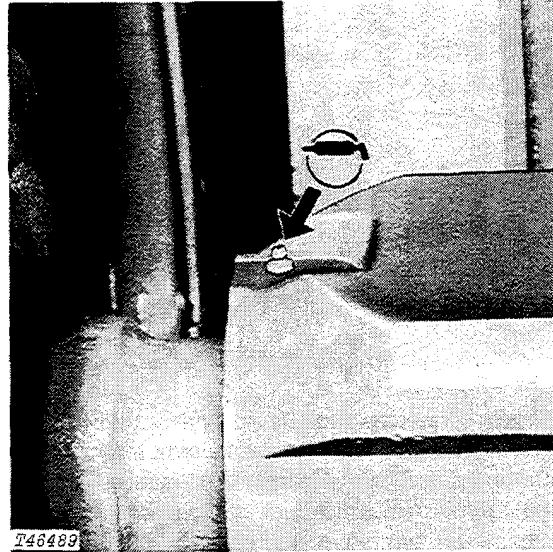

Fig. 9-Axle Bearings (4 points)

Lubricant required Yes No



Fig. 10-Frame Hinge Pivots (2 points)

Lubricant required Yes No

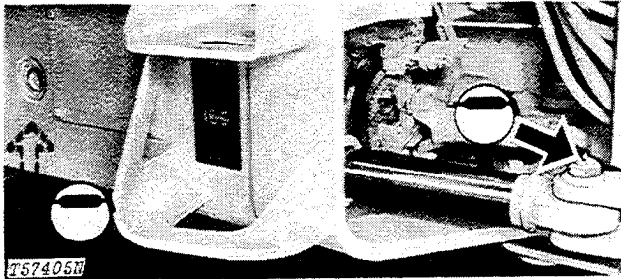

Fig. 11-Steering Cylinder Pivot Pins (4 points)

Lubricant required Yes No



Fig. 12-Front Lower Telescoping Universal Joint (2 points)

Lubricant required Yes No

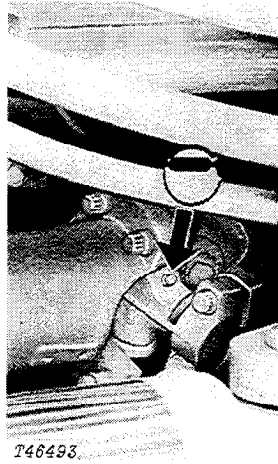

Fig. 13-Rear Lower Telescoping Universal Joint (1 point)

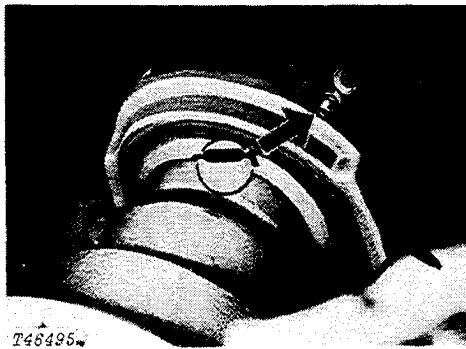

Fig. 14-Lower Drive Shaft Support Bearing (1 point)

Lubricant required Yes No

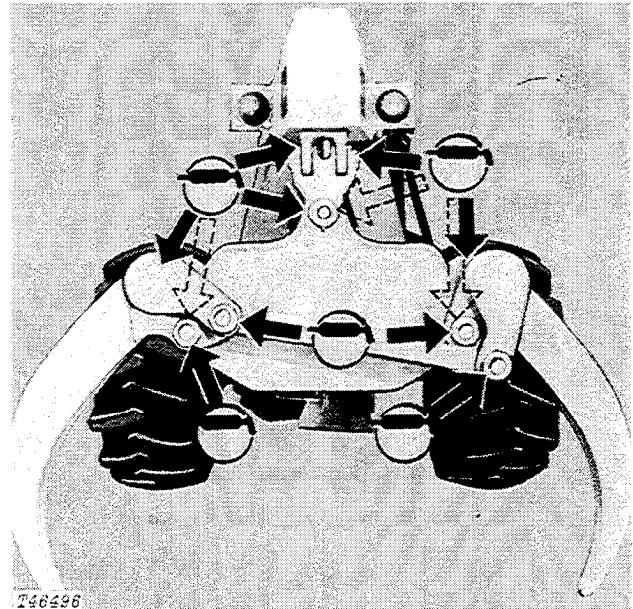

Fig. 15-Grapple Pins (12 points)

Lubricant required Yes No

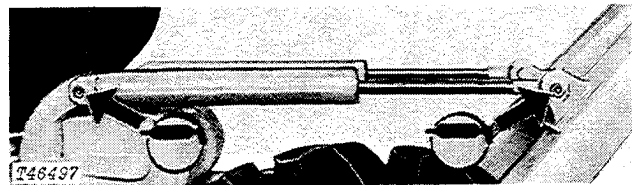

Fig. 16-Boom Cylinder Pins (4 points)

Lubricant required Yes No

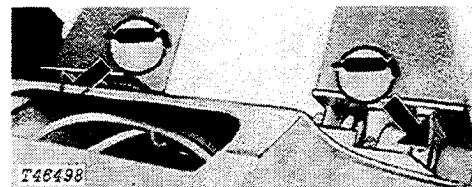

Fig. 17-Boom Pivot Pins (2 points)

Lubricant required Yes No