

**John Deere
740
Skidder**

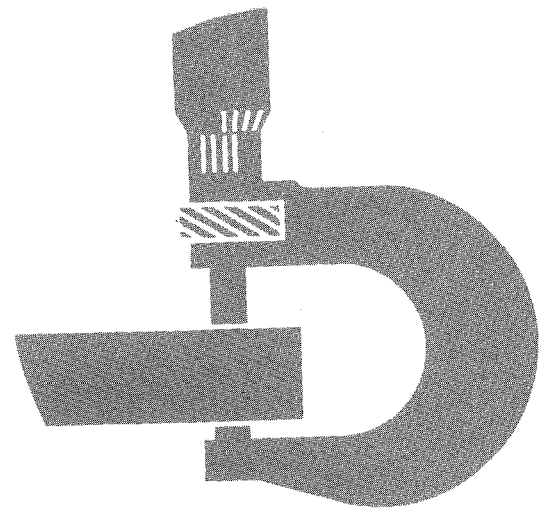

TECHNICAL MANUAL

JD740 SKIDDER
Technical Manual
TM-1059 (Dec-79)

SECTION AND GROUP CONTENTS OF THIS MANUAL

Section I - GENERAL INFORMATION

- Group I Contents and Index
- Group II Introduction and Safety Information

Section 10 - GENERAL

- Group 5 Specifications
- Group 10 Predelivery, Delivery, and After-Sale Services
- Group 15 Lubrication

Section 20 - ENGINE

- Group 4 Engine Removal and Installation
- Group 5 Basic Engine
- Group 10 Engine Lubrication System
- Group 15 Speed Control Linkage
- Group 20 Engine Cooling System
- Group 25 Specifications and Special Tools

Section 30 - FUEL SYSTEM

- Group 5 Fuel Tank and Filters
- Group 10 Air Intake System
- Group 15 Fuel Injection System
- Group 20 Specifications and Special Tools

Section 40 - ELECTRICAL SYSTEM

- Group 5 Batteries
- Group 10 Charging System Components
- Group 15 Starting System Components
- Group 20 Lighting and Accessory Components
- Group 25 Specifications and Special Tools

Section 50 - POWER TRAIN

- Group 5 Engine Disconnect Clutch
- Group 10 Drive Shafts
- Group 15 Power Shift Transmission
- Group 20 Axle Assemblies
- Group 25 Differential
- Group 30 Specifications and Special Tools

Section 60 - HYDRAULIC SYSTEM

- Group 5 Hydraulic Pumps
- Group 10 Auxiliary Winch Drive Motor
- Group 15 Steering Valve
- Group 20 Brake Valve
- Group 25 Miscellaneous Control Valves
- Group 30 Filters, Oil Cooler, Accumulators, and Sump
- Group 35 Cylinders, Lines, and Fittings
- Group 40 Specifications and Special Tools

Section 70 - MISCELLANEOUS

- Group 4 Separation
- Group 5 Main Winch (-218191)
- Group 6 Main Winch (218192-)
- Group 10 Auxiliary Winch
- Group 15 Frames
- Group 16 Fire Suppression System
- Group 17 Fire Extinguisher
- Group 20 Blades
- Group 25 Log Arch
- Group 30 Specifications and Special Tools

Section 80 - TESTING AND DIAGNOSIS

- Group 5 General Information
- Group 10 Engine
- Group 15 Fuel System
- Group 20 Electrical System
- Group 25 Power Train
- Group 30 Hydraulic System
- Group 31 Hydraulic System (Analyzer)
- Group 35 Miscellaneous Components
- Group 40 Specifications and Special Tools

The specifications and design information contained in this manual were correct at the time it was printed. It is John Deere's policy to continually improve and update our machines. Therefore, the specifications and design information are subject to change without notice. Wherever applicable, specifications and design information are in accordance with SAE and ICED standards.

Group II INTRODUCTION AND SAFETY INFORMATION

INTRODUCTION

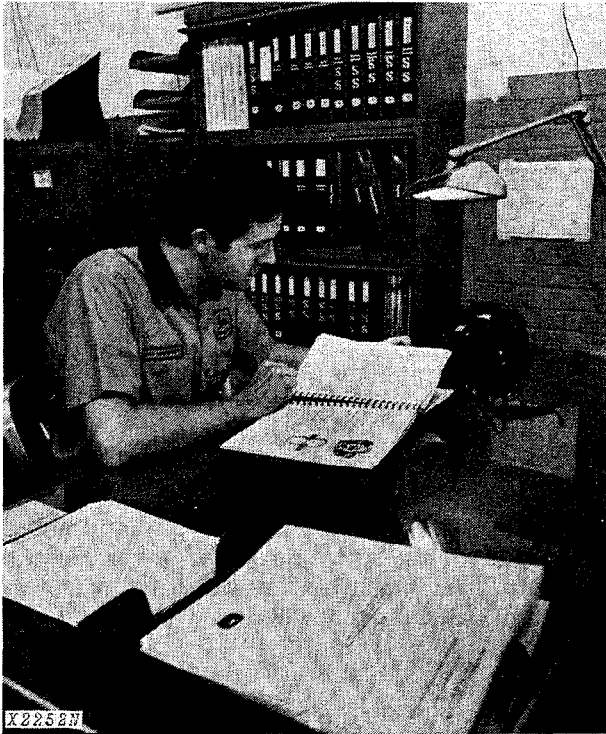

Use FOS Manuals for Reference

This technical manual is part of a twin concept of service:

The two kinds of manuals work as a team to give you both the general background and technical details of shop service.

•FOS Manuals—for reference

Fundamentals of Service (FOS) Manuals cover basic theory of operation, *fundamentals* of trouble shooting, *general* maintenance, and *basic* types of failures and their causes. FOS Manuals are for training new personnel and for reference by experienced service technicians.



When a service technician should refer to a FOS Manual for more information, a FOS symbol like the one at the left is used in the TM to identify the reference.

•Technical Manuals—for actual service

Technical Manuals are concise service guides for a specific machine. Technical manuals are on-the-job guides containing only the vital information needed by an experienced service technician.



Use Technical Manuals for Actual Service

This technical manual was planned and written for you—an experienced service technician. Keep it in a permanent binder in the shop where it is handy. Refer to it whenever in doubt about correct service procedures or specifications.

Some features of this manual:

- Inside front cover - "Table of Contents" and "Maintenance Without Accident".
- Section 10 - General specifications and services.
- Sections 20 through 70 - Removal, repair, testing (components removed), installation, and adjustment.
- Section 80 - Detailed explanation of system operation, diagnosis, visual inspection, testing, and adjustments.
- Specifications grouped and illustrated at the end of each section.
- Inside rear cover - Index.

MAINTENANCE WITHOUT ACCIDENT

WORK SAFELY



T27999N

 This safety alert symbol is used for important safety messages. When you see this symbol, the possibility of personal injury exists if safety message is not followed.

EVERY EMPLOYER HAS A SAFETY PROGRAM. KNOW WHAT IT IS!

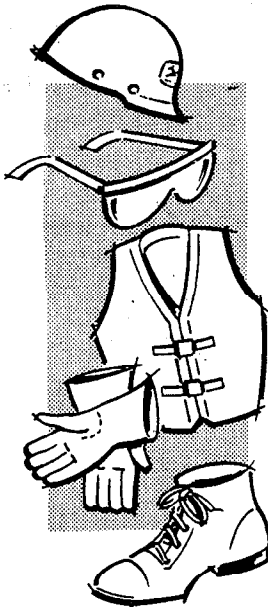

T27501N

Consult your shop foreman for specific instructions on a job, and the safety equipment required.

For instance, you may need: Hard hat, safety shoes, safety goggles, heavy gloves, reflector vests, ear protectors, respirators.



WRONG

T27502N

ALWAYS AVOID loose clothing or any accessory—flopping cuffs, dangling neckties and scarves, or rings and wrist watches—that can catch in moving parts and put you out of work.

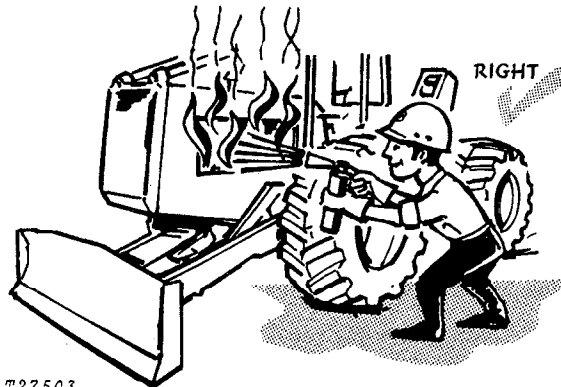

T27503

BE ALERT!

Plan ahead — work safely — avoid accidental damage and injury. If a careless moment does cause an accident or fire, react quickly with the tools and skills at hand — know how to use a first aid kit and a fire extinguisher — and where to get aid and assistance. In an emergency, split-second action is the key to safety.

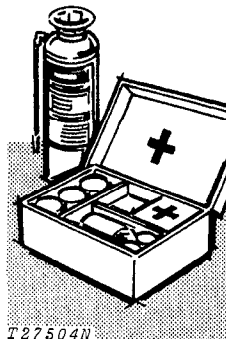

T27504N

MAINTENANCE WITHOUT ACCIDENT

Specific safety procedures should always be observed, whether servicing or making repairs on the skidder. Remembering these—in time!—can prevent an injury...or save your life....

AVOID FIRE HAZARDS—

Fuel Is Dangerous!

- Don't smoke while refueling.
- Don't smoke while handling highly flammable material.
- Engine should be shut off when refueling.
- Use care in refueling if the engine is hot.

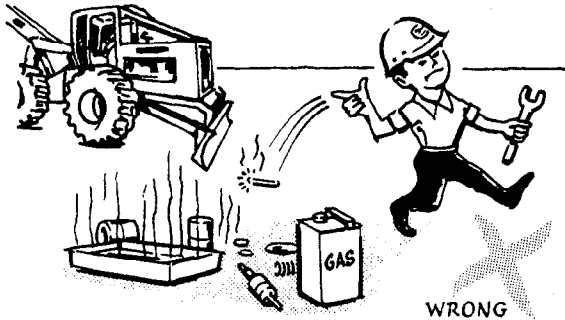

Don't use open pans of gasoline or diesel fuel for cleaning parts. Good commercial, nonflammable solvents are preferred.

Battery Gas Is Highly Flammable!

Provide adequate ventilation when charging batteries.



- Don't check battery charge by placing metal objects across the posts.
- Don't allow sparks or open flame near batteries.
- Don't smoke near battery.

Flame Is Not a Flashlight!

Never check fuel, battery electrolyte or coolant levels with an open flame.

Never use an open flame to look for leaks anywhere on the equipment.

Never use an open flame as a light anywhere on or around the equipment.

KNOW WHERE FIRE EXTINGUISHERS ARE KEPT!

UNDER ALL MAINTENANCE CONDITIONS—

Do not perform any work on the skidder unless authorized to do so. Then be sure you understand the services required. Follow recommended procedures.

Never service the equipment while it is being operated.

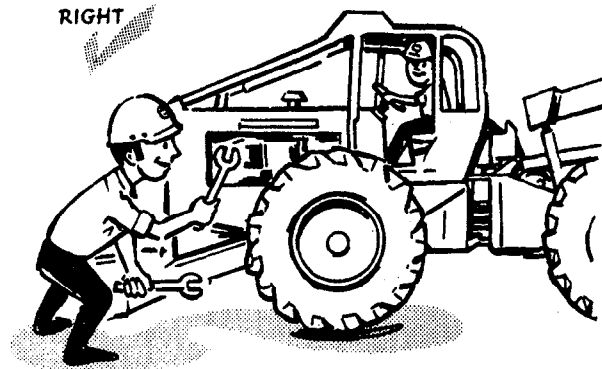

Avoid working on equipment with the engine running. If it is necessary to make checks with the engine running, **ALWAYS USE TWO SERVICE TECHNICIANS**—one, the operator, at the controls, the other checking within view of the operator. Also, put the transmission in neutral, set the brake, and apply any safety locks provided. **KEEP HANDS AWAY FROM MOVING PARTS.**

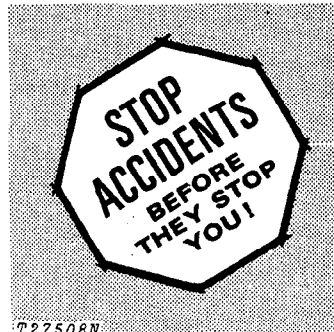

MAINTENANCE WITHOUT ACCIDENT

Before servicing, adjusting, or repairing skidders which have attachments such as blades, etc. — **LOWER** attachments to the ground — or, if necessary to raise them for access to certain parts, **SECURELY SUPPORT** by external means. **DO NOT** rely on controls to support or position attachments for maintenance.

Never allow **ANYONE** to walk under equipment that is raised and not properly blocked.

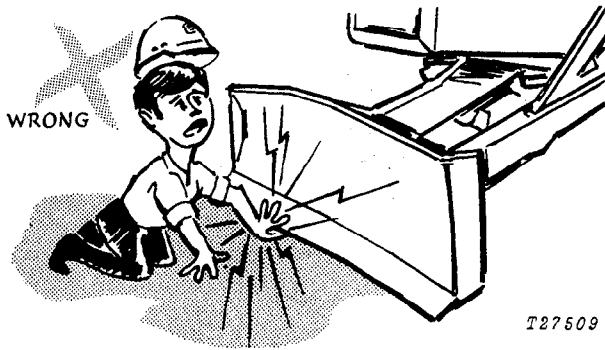

Avoid working directly under raised and blocked equipment unless absolutely necessary.

If the skidder is on an incline, block it securely.

Use hoisting equipment for lifting heavy parts. **TAKE CARE! WATCH OUT FOR OTHER PEOPLE IN THE VICINITY.**

Use extreme caution in removing radiator caps, drain plugs, grease fittings, or hydraulic pressure caps.

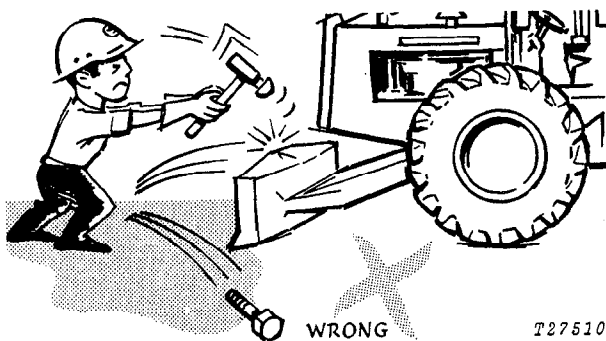

Wear safety glasses when drilling, grinding, or hammering metal.

Make sure the maintenance area is adequately vented.

Keep maintenance area **CLEAN AND DRY**. Oily and wet floors are slippery; greasy rags are a fire hazard; wet spots are dangerous when working with electrical equipment.

Store starting aids in a cool and well-ventilated place, out of the reach of unauthorized personnel.

SERVICING PRECAUTIONS

Stop the engine before cleaning or lubricating the skidder.

Lower mounted equipment and tools to the ground *carefully*.

Engine coolant gets hot! Don't remove the radiator cap until coolant temperature is below the boiling point. Then turn cap slightly to relieve pressure before removing.

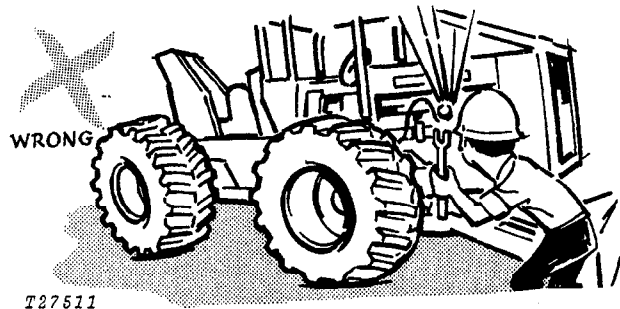

Exhaust gases are dangerous! Periodically check exhaust system for excessive leakage.

Don't forget the hydraulic system may be pressurized! To relieve system pressure, stop engine, lower blade and operate blade control lever, brakes, and steering wheel until system fails to respond.

When checking hydraulic pressure, be sure to use the correct test gauge for the pressure in the particular system.

The skidder is equipped with a brake accumulator—recharge by using only dry nitrogen. To discharge brake accumulator apply the brake pedal about 30 times.

**Thank you very much
for your reading. Please
Click Here Then Get
More Information.**

NOTE:

**If there is no response to
click on the link above,
please download the PDF
document first and then
click on it.**

MAINTENANCE WITHOUT ACCIDENT

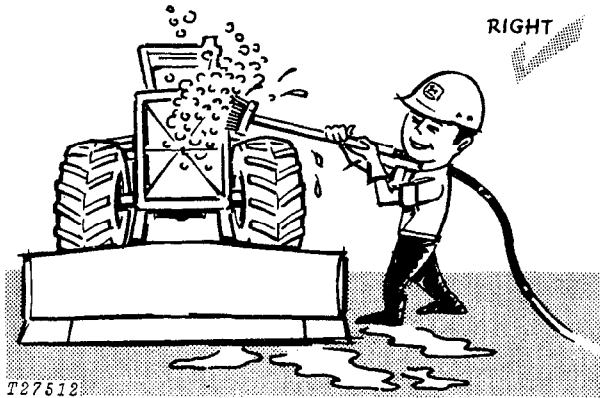

Keep ALL components free of dirt and oil. This attention will minimize fire hazards and facilitate spotting of loose or defective parts.

When preparing engine for storage, remember that inhibitor is volatile and therefore dangerous. Seal and tape openings after adding inhibitor. Keep container tightly closed when not in use.

ADJUSTING PRECAUTIONS

...for Operating Adjustments

Keep clutch and brake control units properly adjusted at all times. Before making adjustments, stop engine.

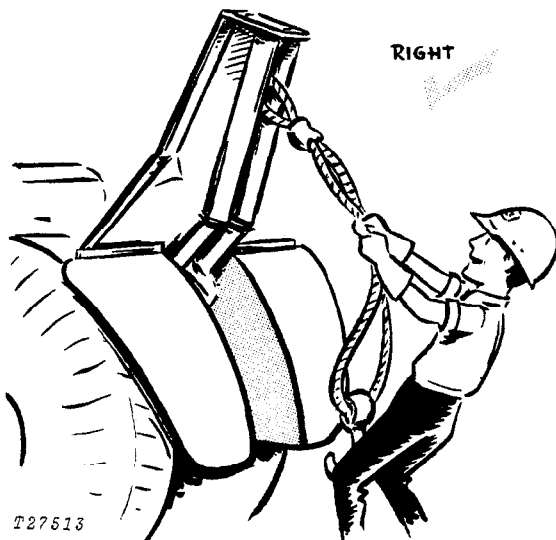

Always wear gloves when handling cable.

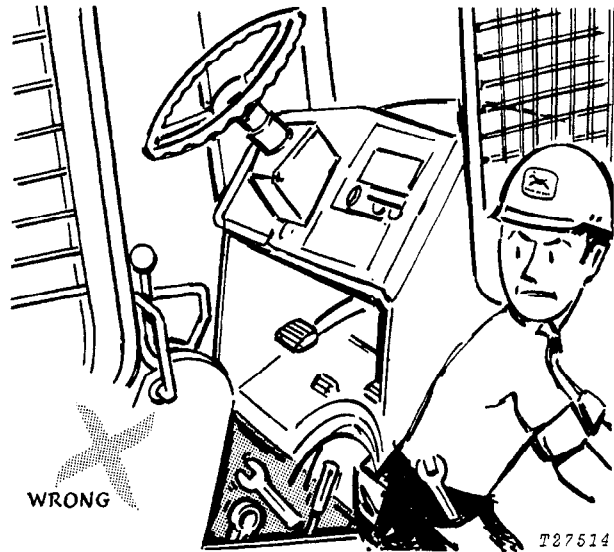

Before removing any housing covers, stop engine. Take all objects from your pockets which could fall into the opened housings. Don't let adjusting wrenches fall into opened housings.

...for Maintenance Adjustments

Don't attempt to check belt tension while the engine is running.

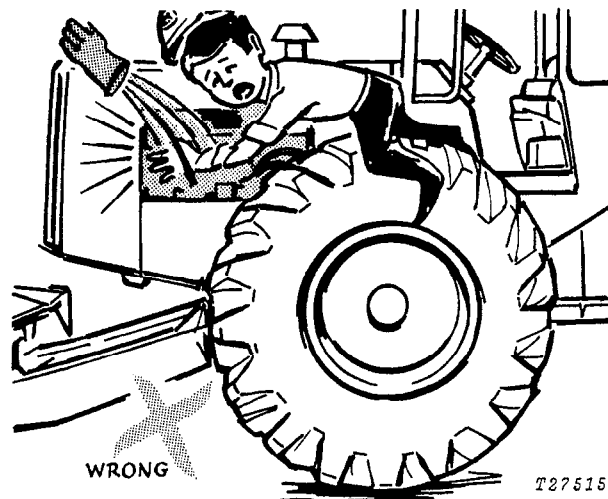

Don't adjust the fuel system while the machine is in motion.

MAINTENANCE WITHOUT ACCIDENT

PRECAUTIONS DURING REPAIR

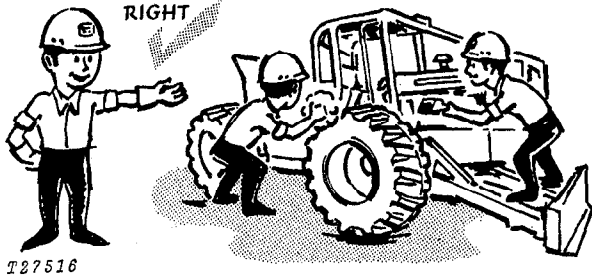

Keep all equipment free of dirt and oil. This attention will minimize fire hazards and facilitate spotting of loose or defective parts.

Before repairing the electrical system, or performing a major overhaul, make sure the batteries are disconnected.

When changing cutting edges on blade—

Stop the engine and securely block the blade.

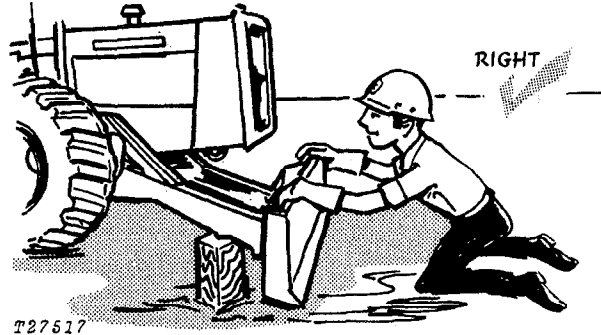

Never let your bare hands come in contact with the sharp edges. WEAR GLOVES.

MAINTENANCE WITHOUT ACCIDENT

KNOW EQUIPMENT IS READY!

Check guards, canopies, safety bars—all protective devices installed on the skidder. Every one should be in place and secure.

CHECK IT OUT!

- GUARDS
- CANOPIES
- SHIELDS
- PROTECTIVE DEVICES
- ROLL-OVER PROTECTIVE STRUCTURES
- SEAT BELTS
- FIRE EXTINGUISHER
- FIRE SUPPRESSION SYSTEM, ETC.

RIGHT

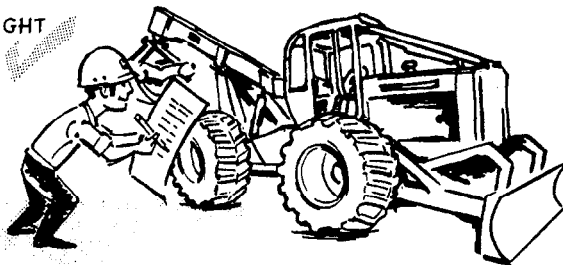

T33262N

Carefully inspect equipment for visual defects — leaks in fuel, lubrication, and hydraulic systems. Do not search for pressurized fluid leaks with your hands. Use cardboard or wood to search for leaks.

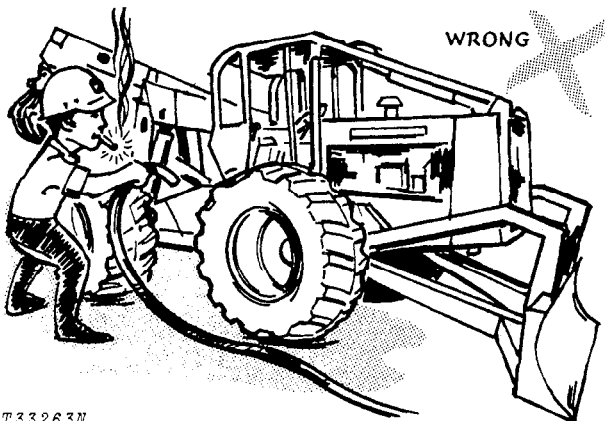

T33263N

Check levels of fuel, coolant, hydraulic fluid, and lubricating oil. If fuel must be added — **FIRST, PUT OUT THAT CIGARETTE.**

Check and secure all caps and filler plugs for fuel, oils, radiator, etc.

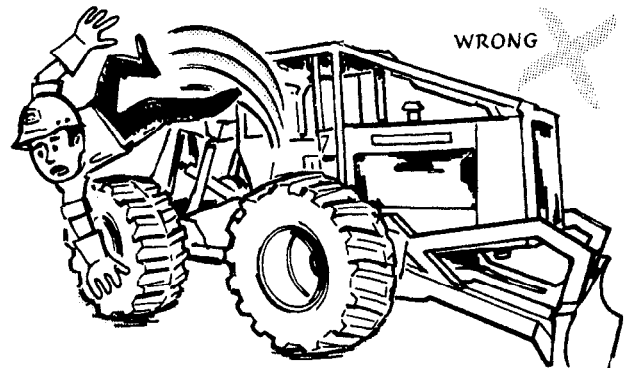

T33264N

Be sure to clean any oil, grease or mud accumulation from floor of operator's compartment, stepping points, and grab rails to minimize the danger of slipping.

In freezing weather beware of snow or ice deposits on stepping points, grab rails, and floor.

Remove loose bolts, tools, or other objects from floor of operator's compartment.

Although it is impractical to try to cover every possible maintenance situation, the safety precautions recommended here should serve to develop and promote safe maintenance procedures.

The information contained in this manual is not intended to replace safety codes, insurance requirements, federal, state, and local laws, rules and regulations. In particular, your service area or jobsite activities may be subject to state safety rules and/or federal regulation under the Occupational Safety and Health Act (OSHA). Familiarize yourself with all regulations applicable to your situation in order to avoid possible safety violations.

Illustrations and copy reproduced in part by permission of Construction Industry Manufacturers' Association (CIMA).

Section 10 GENERAL

CONTENTS OF THIS SECTION

	Page		Page
GROUP 5 - SPECIFICATIONS		GROUP 15 - LUBRICATION	
General Machine Specifications	5-2	General Information	15-1
GROUP 10 - PREDELIVERY, DELIVERY, AND AFTER SALE SERVICES		Skidder Periodic Service Chart	15-1
Temporary Machine Storage	10-1	Engine Lubricating Oil	15-2
Predelivery Service	10-1	Transmission-Hydraulic Oils	15-2
Delivery Service	10-15	Greases	15-2
After Sales Inspection	10-15		

Group 5

GENERAL MACHINE SPECIFICATIONS

POWER

(at 2,200 engine rpm):	SAE	DIN
Gross	160 hp (119.3 kW*)	
Net	145 hp (108.1 kW*)	147 PS

Net engine flywheel power is for an engine equipped with fan, air cleaner, water pump, lubricating oil pump, fuel pump, alternator, and muffler. The gross engine power is without fan. Gross and net flywheel power ratings are under SAE standard conditions at 500-ft. (152 m) altitude and 85°F (29°C) temperature and DIN 70 020 (non-corrected). No derating is required up to 10,000 feet (3,000 m) altitude.

*In the International System of Units (SI), power is expressed in kilowatts (kW).

ENGINE:

John Deere Diesel, vertical 6-cylinder, valve-in-head, 4-stroke cycle—turbocharged and intercooled.

Bore and stroke	4.25x4.75 in. (108x121 mm)
Piston displacement	404 cu. in. (6620 cm ³)
Compression ratio	15.5 to 1
Maximum torque @ 1,400 rpm	457 lb-ft (63.2 kg-m)
N.A.C.C. or A.M.A. (U.S. Tax) horsepower	43.3
Lubrication	Pressure system with full-flow filter
Cooling	Pressurized with thermostat and fixed bypass
Fan	Blower
Air cleaner with restriction indicator	Dry
Starting system	12-volt with alternator
Batteries, two	Reverse capacity: 180 minutes each

DIFFERENTIALS:

Front and rear

ENGINE CLUTCH DISCONNECT:

Hand-operated, spring-loaded, dry-disk. Single plate, 12 in. (305 mm).

TRANSMISSION:

Power Shift with planetary gears, hydraulically actuated wet-disk clutches and brakes; provides 8 speeds forward—4 reverse. Controlled by single lever. Pressurized lubrication.

TRAVEL SPEEDS (2,200 engine rpm, no tire slip):

Forward: 1.78 mph (2.86 km/h) to 19.38 mph (31.19 km/h)
Reverse: 2.29 mph (3.69 km/h) to 6.65 mph (10.70 km/h)

BRAKES:

Service... Hydraulic power-actuated, pedal-controlled, wet-disk on 4 wheels.

Winching

Parking

POWER STEERING

Articulated frame hydraulically actuated by dual cylinders.	
Turning radius	17 ft. 5 in. (5.31 m)
Turning clearance	37 ft. 1 in. (11.30 m)
Number of turns, far left to far right	3

HYDRAULIC SYSTEM:

Closed-center, constant pressure. Variable-displacement pump driven from crankshaft... 50.2 gpm (190 Lpm), 2,000 psi (140.6 kg-cm²) @ 2,200 engine rpm. Oil cooler included in system.

TIRES:

- *24.5-32, 16-ply-rating, kevlar-ply, LS-2
- *30.5-32, 16-ply-rating, kevlar-ply, LS-2
- 24.5-32, 12-ply-rating, steel-ply, logging, LS-2
- 24.5-32, 16-ply-rating, steel-ply, LS-2
- 30.5-32, 12-ply-rating, steel-ply, LS-2
- 30.5-32, 16-ply-rating, steel-ply, LS-2
- *Canada only

DRIVE AXLES:

Four-wheel drive with inboard planetary gears on all axles. Front axle oscillates 15 degrees above and below horizontal. 24.9 in. (632 mm) total travel at tire center line at narrowest tread.

WINCH:

Cable capacities*:

	Auxiliary	Main
1/2-in. (12.7 mm) cable ...	150 ft. (45.72 m)	577 ft. (175.9 m)
5/8-in. (15.8 mm) cable ...	125 ft. (38.10 m)	379 ft. (115.5 m)
3/4-in. (19.1 mm) cable ...	100 ft. (30.48 m)	267 ft. (81.5 m)
7/8-in. (22.2 mm) cable ...	192 ft. (58.5 m)	192 ft. (58.5 m)
1-in. (25.4 mm)	149 ft. (45.4 m)	149 ft. (45.4 m)

*Calculated: No allowance made for loose or uneven spooling.

Line pull (maximum engine torque):

Bare drum	13,100 lb. (5942 kg)	49,397 lb. (22406 kg)
Full drum	7,850 lb. (3561 kg)	28,227 lb. (12804 kg)

Line speed (2,200 rpm):

Bare drum	115 fpm (32.1 m/min.)	116 fpm (35.5 m/min.)
Full drum	185 fpm (56.4 m/min.)	204 fpm (62 m/min.)

ARCH:

Horizontal rollers

Vertical rollers

(through-hardened steel)

Working height (top of horizontal roller to ground): Adjustable to 4 positions.

CAPACITIES:

	U.S.	Liters
Fuel tank	54 gal.	204.4
Cooling system	12 gal.	45.4
Engine lubrication, including filter	20 qt.	18.9
Transmission-hydraulic system	30.5 gal.	115.5
Front differential	26 qt.	24.6
Rear differential	26 qt.	24.6

OPERATING WEIGHT

ADDITIONAL STANDARD EQUIPMENT:

Exhaust with rain deflector	Engine side shields
Fuel level dipstick	Deluxe seat with suspension
Transistorized voltage regulator	Foot throttle
Electric hour meter	Hand throttle
Key-switch with push-button safety start	Hinge lock bar
Fire extinguishers (2)	Roll-over protective structure (ROPS) with canopy and seat belt
Bottom guards	and brush screens
Cold weather starting aid	Lights
Vandal protection	Horn
Cigar lighter	Muffler
Parking brake	

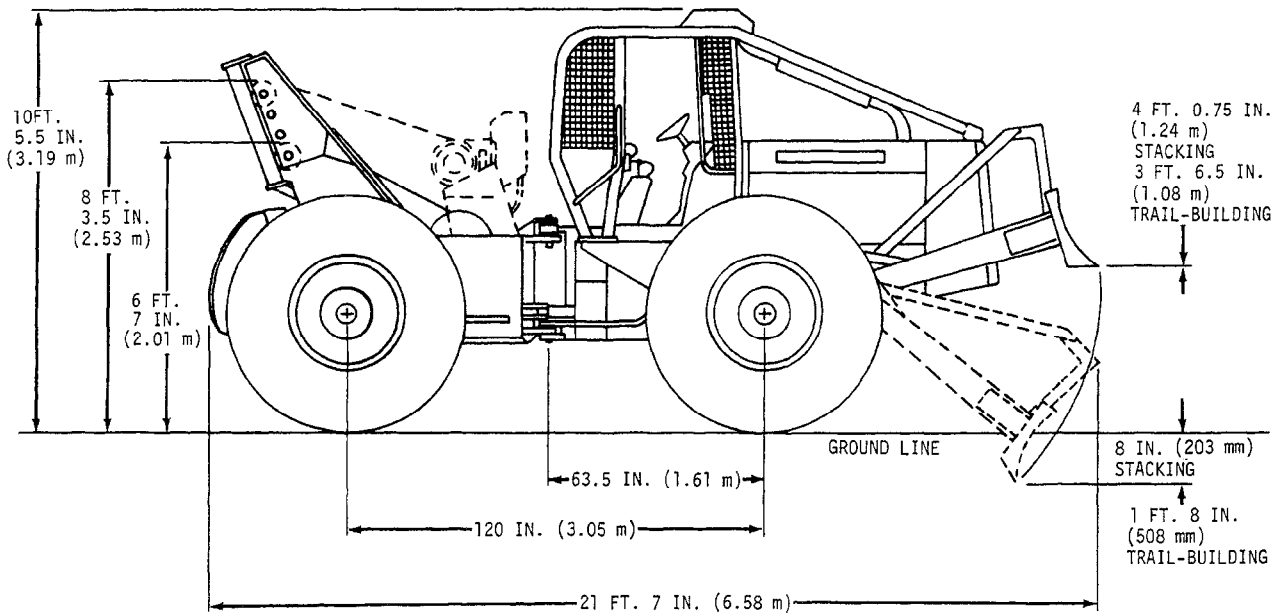

T45023

Sideview dimensions are for skidder equipped with 30.5-32 tires

DIMENSIONS:

TIRE SIZE	A WHEEL TREAD	B GROUND CLEARANCE	C OVER-ALL WIDTH
24.5-32	93 in. (2.36 m)	21.6 in. (549 mm)	9 ft. 9.5 in. (2.98 m)
30.5-32	97 in. (2.46 m)	20 in. (508 mm)	10 ft. 7.5 in. (3.24 m)

BLADE DIMENSIONS:

D WIDTH TRAIL-BUILDING	E WIDTH STACKING	F HEIGHT TRAIL-BUILDING	G HEIGHT STACKING
9 ft. 4 in. (2.84 m)	7 ft. 2 in. (2.18 m)	2 ft. 8 in. (813 mm)	1 ft. 8.5 in. (521 mm)

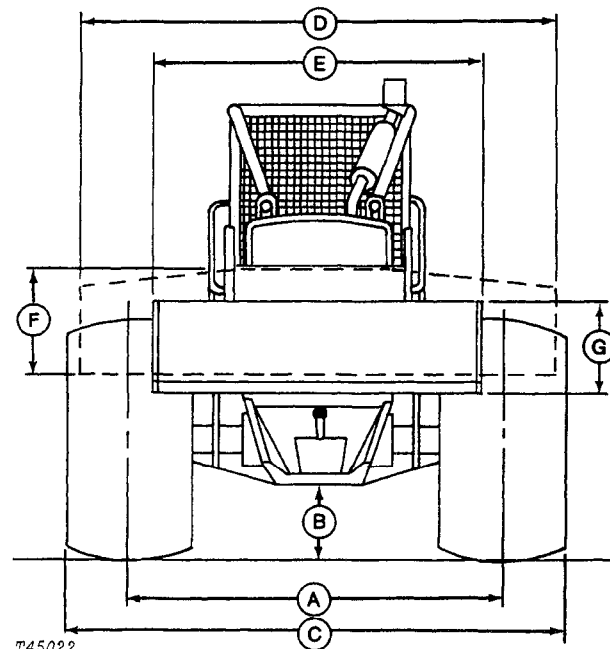

T45022

SPECIAL EQUIPMENT:

- Auxiliary winch and roller
- Stacking blade
- Wheel weights
- Drawbar with clevis
- Windshield with wipers
- Cab with noise package
- Pressurized cab with heater
- Depth gauge shoe assembly
- Trail blade vertical extension
- Remote hydraulic system
- Automatic fire suppression system
- Engine coolant heater

(Specifications and design are subject to change without notice. Wherever applicable, specifications are in accordance with ICED and SAE Standards. Except where otherwise noted these specifications are based on a unit equipped with 30.5-32, 12-ply-rating steel ply tires and standard equipment.)

Group 10 PREDELIVERY, DELIVERY AND AFTER-SALE SERVICES

TEMPORARY STORAGE

After receiving your skidder from the factory and before putting the skidder into temporary storage, perform the following checks.

1. Check battery electrolyte level and charge the battery, if necessary.
2. Check coolant level in the radiator. The coolant should be maintained at a level midway between the radiator core and filler neck.
3. Check crankcase oil level. Oil should be at top mark on dipstick after machine has been shut down for 10 minutes.
4. Relieve hydraulic pressure by lowering blade, stopping engine, and operating blade control lever, brakes, and steering wheel until system fails to respond.

PREDELIVERY SERVICE

Because of the shipping factors involved, plus extra finishing touches that are necessary to promote customer satisfaction, proper predelivery service is of prime importance to the dealer and the customer.

If adjustments are required, procedures are found in the After-Sale section.

Use the following list when preparing a skidder for delivery to the customer.

1. Air Cleaner

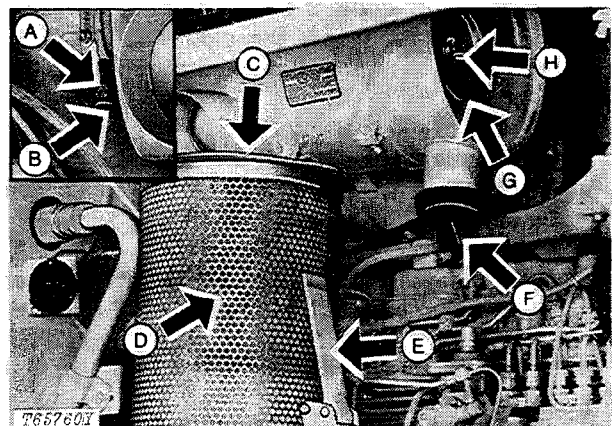

- | | |
|-------------------------|------------------|
| A—Restriction Indicator | E—Lever |
| B—Reset Button | F—Unloader Valve |
| C—Air Cleaner Cover | G—Safety Element |
| D—Primary Element | H—Wing Nut |

Fig. 1—Air Cleaner Components

Check air cleaner restriction indicator. If the restriction indicator locks in full view, look for restriction or blockage in air intake system.

Air cleaner elements checked	Yes	No
Restriction in system	Yes	No