

LT133, LT155 & LT166 Lawn Tractors

TECHNICAL MANUAL

**John Deere
Worldwide Commercial and
Consumer Equipment Division**

**TM1695 (20Sep00)
Replaces TM1695 (15Sep98)**



M85699



M85700



M85701

This technical manual is written for an experienced technician and contains sections that are specifically for this product. It is a part of a total product support program.

The manual is organized so that all the information on a particular system is kept together. The order of grouping is as follows:

- Table of Contents
- General Diagnostic Information
- Specifications
- Electrical Wiring Harness Legend
- Component Location
- System Schematic
- Wiring Harness
- Troubleshooting Chart
- Theory of Operation
- Diagnostics
- Tests & Adjustments
- Repair











Note: Depending on the particular section or system being covered, not all of the above groups may be used.

Each section will be identified with a symbol rather than a number. The groups and pages within a section will be consecutively numbered.

We appreciate your input on this manual. To help, there are postage paid post cards included at the back. If you find any errors or want to comment on the layout of the manual please fill out one of the cards and mail it back to us.

All information, illustrations and specifications in this manual are based on the latest information available at the time of publication. The right is reserved to make changes at any time without notice.

COPYRIGHT© 2000
Deere and Co.
John Deere Worldwide Commercial and
Consumer Equipment Division
Horicon, WI
All rights reserved

Safety	
Specifications and Information	
Kohler Engines	
Briggs & Stratton Engine	
Electrical	
Power Train (Gear)	
Power Train (Hydrostatic)	
Steering	
Brakes	
Attachments	
Miscellaneous	M



SAFETY

RECOGNIZE SAFETY INFORMATION



This is the safety-alert symbol. When you see this symbol on your machine or in this manual, be alert to the potential for personal injury.

Follow recommended precautions and safe servicing practices.

UNDERSTAND SIGNAL WORDS

A signal word—**DANGER**, **WARNING**, or **CAUTION**—is used with the safety-alert symbol. **DANGER** identifies the most serious hazards.

DANGER or **WARNING** safety signs are located near specific hazards. General precautions are listed on **CAUTION** safety signs. **CAUTION** also calls attention to safety messages in this manual.

REPLACE SAFETY SIGNS



Replace missing or damaged safety signs. See the machine operator's manual for correct safety sign placement.

HANDLE FLUIDS SAFELY-AVOID FIRES

BE PREPARED FOR EMERGENCIES

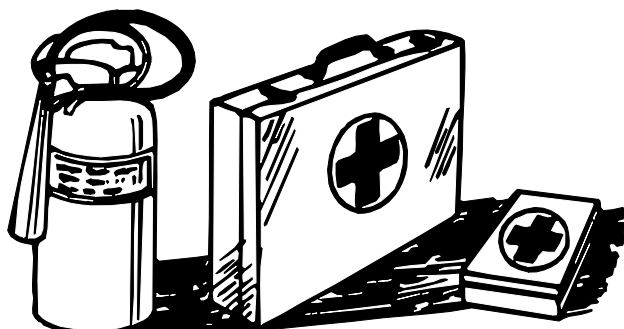

When you work around fuel, do not smoke or work near heaters or other fire hazards.

Store flammable fluids away from fire hazards. Do not incinerate or puncture pressurized containers.

Make sure machine is clean of trash, grease, and debris.

Do not store oily rags; they can ignite and burn spontaneously.

Be prepared if a fire starts.

Keep a first aid kit and fire extinguisher handy.

Keep emergency numbers for doctors, ambulance service, hospital, and fire department near your telephone.

USE CARE IN HANDLING AND SERVICING BATTERIES

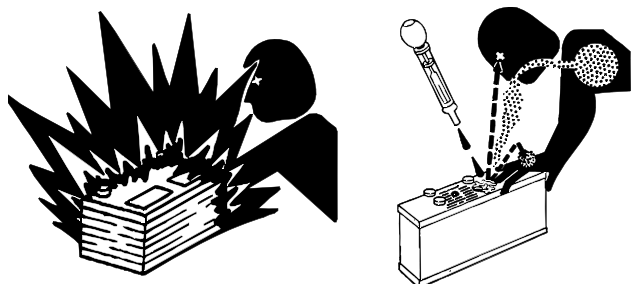

PREVENT BATTERY EXPLOSIONS

- Keep sparks, lighted matches, and open flame away from the top of battery. Battery gas can explode.
- Never check battery charge by placing a metal object across the posts. Use a volt-meter or hydrometer.
- Do not charge a frozen battery; it may explode. Warm battery to 16°C (60°F).

PREVENT ACID BURNS

- Sulfuric acid in battery electrolyte is poisonous. It is strong enough to burn skin, eat holes in clothing, and cause blindness if splashed into eyes.
- **Avoid acid burns by:**
 1. Filling batteries in a well-ventilated area.
 2. Wearing eye protection and rubber gloves.
 3. Avoiding breathing fumes when electrolyte is added.
 4. Avoiding spilling or dripping electrolyte.
 5. Use proper jump start procedure.
- **If you spill acid on yourself:**
 1. Flush your skin with water.
 2. Apply baking soda or lime to help neutralize the acid.
 3. Flush your eyes with water for 10_15 minutes.
 4. Get medical attention immediately.
- **If acid is swallowed:**
 1. Drink large amounts of water or milk.
 2. Then drink milk of magnesia, beaten eggs, or vegetable oil.
 3. Get medical attention immediately.

USE SAFE SERVICE PROCEDURES

WEAR PROTECTIVE CLOTHING



Wear close fitting clothing and safety equipment appropriate to the job.

Prolonged exposure to loud noise can cause impairment or loss of hearing. Wear a suitable hearing protective device such as earmuffs or earplugs to protect against objectionable or uncomfortable loud noises.

Operating equipment safely requires the full attention of the operator. Do not wear radio or music headphones while operating machine.

SERVICE MACHINES SAFELY

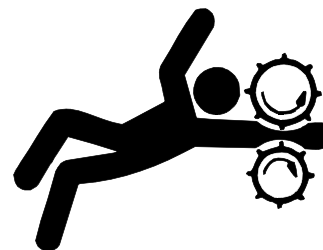

Tie long hair behind your head. Do not wear a necktie, scarf, loose clothing, or necklace when you work near machine tools or moving parts. If these items were to get caught, severe injury could result.

Remove rings and other jewelry to prevent electrical shorts and entanglement in moving parts.

USE PROPER TOOLS

Use tools appropriate to the work. Makeshift tools and procedures can create safety hazards. Use power tools only to loosen threaded parts and fasteners. For loosening and tightening hardware, use the correct size tools. **DO NOT** use U.S. measurement tools on metric fasteners. Avoid bodily injury caused by slipping wrenches. Use only service parts meeting John Deere specifications.



PARK MACHINE SAFELY

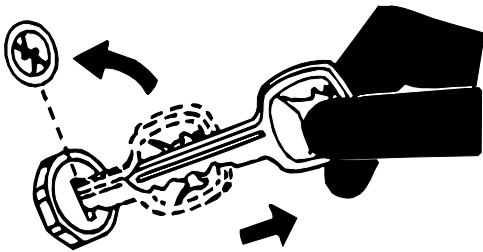

Before working on the machine:

1. Lower all equipment to the ground.
2. Stop the engine and remove the key.
3. Disconnect the battery ground strap.
4. Hang a "DO NOT OPERATE" tag in operator station.

SUPPORT MACHINE PROPERLY AND USE PROPER LIFTING EQUIPMENT

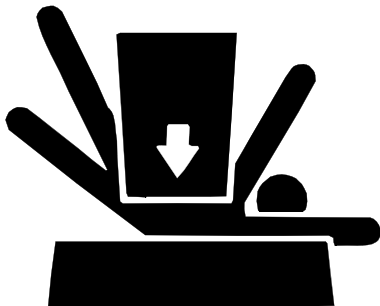

If you must work on a lifted machine or attachment, securely support the machine or attachment. Do not support the machine on cinder blocks, hollow tiles, or props that may crumble under continuous load. Do not work under a machine that is supported solely by a jack. Follow recommended procedures in this manual. Lifting heavy components incorrectly can cause severe injury or machine damage. Follow recommended procedure for removal and installation of components in the manual.

WORK IN CLEAN AREA

Before starting a job:

1. Clean work area and machine.
2. Make sure you have all necessary tools to do your job.
3. Have the right parts on hand.
4. Read all instructions thoroughly; do not attempt shortcuts.

USING HIGH PRESSURE WASHERS

Directing pressurized water at electronic/electrical components or connectors, bearings, hydraulic seals, fuel injection pumps or other sensitive parts and components may cause product malfunctions. Reduce pressure and spray at a 45 to 90 degree angle.

ILLUMINATE WORK AREA SAFELY

Illuminate your work area adequately but safely. Use a portable safety light for working inside or under the machine. Make sure the bulb is enclosed by a wire cage. The hot filament of an accidentally broken bulb can ignite spilled fuel or oil.

WORK IN VENTILATED AREA

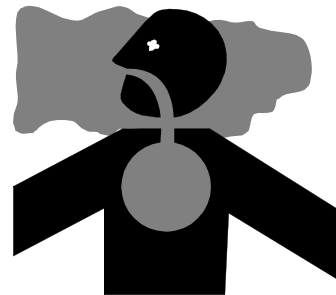

Engine exhaust fumes can cause sickness or death. If it is necessary to run an engine in an enclosed area, remove the exhaust fumes from the area with an exhaust pipe extension.

If you do not have an exhaust pipe extension, open the doors and get outside air into the area.

WARNING: CALIFORNIA PROPOSITION 65 WARNING

Gasoline engine exhaust from this product contains chemicals known to the State of California to cause cancer, birth defects, or other reproductive harm.

REMOVE PAINT BEFORE WELDING OR HEATING

Avoid potentially toxic fumes and dust. Hazardous fumes can be generated when paint is heated by welding, soldering, or using a torch. Do all work outside or in a well ventilated area. Dispose of paint and solvent properly. Remove paint before welding or heating: If you sand or grind paint, avoid breathing the dust. Wear an approved respirator. If you use solvent or paint stripper, remove stripper with soap and water before welding. Remove solvent or paint stripper containers and other flammable material from area. Allow fumes to disperse at least 15 minutes before welding or heating.

AVOID HARMFUL ASBESTOS DUST

Avoid breathing dust that may be generated when handling components containing asbestos fibers. Inhaled asbestos fibers may cause lung cancer. Components in products that may contain asbestos fibers are brake pads, brake band and lining assemblies, clutch plates, and some gaskets. The asbestos used in these components is usually found in a resin or sealed in some way. Normal handling is not hazardous as long as airborne dust containing asbestos is not generated.

Avoid creating dust. Never use compressed air for cleaning. Avoid brushing or grinding material containing asbestos. When servicing, wear an approved respirator. A special vacuum cleaner is recommended to clean asbestos. If not available, apply a mist of oil or water on the material containing asbestos. Keep bystanders away from the area.

SERVICE TIRES SAFELY



Explosive separation of a tire and rim parts can cause serious injury or death.

Do not attempt to mount a tire unless you have the proper equipment and experience to perform the job.

Always maintain the correct tire pressure. Do not inflate the tires above the recommended pressure. Never weld or heat a wheel and tire assembly. The heat can cause an increase in air pressure resulting in a tire explosion. Welding can structurally weaken or deform the wheel.

When inflating tires, use a clip-on chuck and extension hose long enough to allow you to stand to one side and NOT in front of or over the tire assembly. Use a safety cage if available.

Check wheels for low pressure, cuts, bubbles, damaged rims or missing lug bolts and nuts.

AVOID INJURY FROM ROTATING BLADES, AUGERS AND PTO SHAFTS

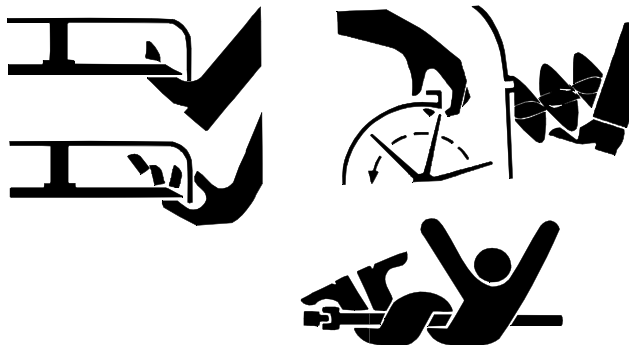

Keep hands and feet away while machine is running. Shut off power to service, lubricate or remove mower blades, augers or PTO shafts.

HANDLE CHEMICAL PRODUCTS SAFELY

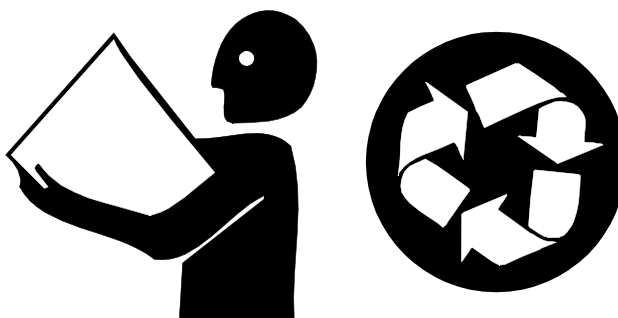

Direct exposure to hazardous chemicals can cause serious injury. Potentially hazardous chemicals used with John Deere equipment include such items as lubricants, coolants, paints, and adhesives.

A Material Safety Data Sheet (MSDS) provides specific details on chemical products: physical and health hazards, safety procedures, and emergency response techniques. Check the MSDS before you start any job using a hazardous chemical. That way you will know exactly what the risks are and how to do the job safely. Then follow procedures and recommended equipment.



DISPOSE OF WASTE PROPERLY

Improperly disposing of waste can threaten the environment and ecology. Potentially harmful waste used with John Deere equipment include such items as oil, fuel, coolant, brake fluid, filters, and batteries. Use leakproof containers when draining fluids. Do not use food or beverage containers that may mislead someone into drinking from them. Do not pour waste onto the ground, down a drain, or into any water source. Inquire on the proper way to recycle or dispose of waste from your local environmental or recycling center, or from your John Deere dealer.

LIVE WITH SAFETY



Before returning machine to customer, make sure machine is functioning properly, especially the safety systems. Install all guards and shields.

CONTENTS

Page



SPECIFICATIONS

GENERAL VEHICLE SPECIFICATIONS	3
METRIC FASTENER TORQUE VALUES	6
METRIC FASTENER TORQUE VALUE—GRADE 7	7
INCH FASTENER TORQUE VALUES	8
GASOLINE	9
GASOLINE STORAGE	9
LUBRICANTS	10
ENGINE OIL - KOHLER ENGINE	10
ENGINE OIL - BRIGGS & STRATTON ENGINE	10
ENGINE BREAK-IN OIL	11
ANTI-CORROSION GREASE	11
ALTERNATIVE LUBRICANTS	12
SYNTHETIC LUBRICANTS	12
LUBRICANT STORAGE	12
MIXING OF LUBRICANTS	12
CHASSIS GREASE	12
GEAR TRANSMISSION GREASE	13
HYDROSTATIC TRANSMISSION OIL	13
SERIAL NUMBER LOCATION	14



GENERAL VEHICLE SPECIFICATIONS

ENGINE SPECIFICATIONS

KOHLER ENGINES—LT133 and LT155

Make	Kohler
Model / Model Number:	
LT133	Command LT / CV13S-21525
LT155	Command 15 QT / CV15S-41562
Power:	
LT133	9.7 kW (13.0 hp)
LT155	11.2 kW (15.0 hp)
Displacement:	
LT133	.398 cm ³ (24.3 cu-in.)
LT155	.426 cm ³ (26.0 cu-in.)
Cylinders	1
Stroke/Cycle	4
Valves	Overhead Valves
Lubrication	Pressurized
Oil Filter	Single Element, Full Flow, Spin-On Filter
Crankcase Capacity (With Filter)	1.8 L (1.9 qt)
Without Filter	1.4 L (1.5 qt)
Cooling System	Air Cooled
Air Cleaner	Paper with outer foam element
Muffler	Horizontal discharge below frame
Spark Plug Gap	1.0 mm (0.040 in.)

BRIGGS & STRATTON—LT166

Make	Briggs & Stratton
Series	Vanguard V-Twin
Type	916928 Gasoline
Model	303777
Horsepower	11.9 kW (16.0 hp)
Displacement	480 cm ³ (29.3 cu. in.)
Cylinders	2
Stroke/Cycle	4
Valves	Overhead Valves
Lubrication	Pressurized
Oil Filter	Full Flow Filter (w/o By-Pass Valve)
Crankcase Capacity (With Filter)	1.5 L (1.6 qt)
Without Filter	1.4 L (1.5 qt)
Cooling System	Air Cooled
Air Cleaner	Paper with outer foam element
Muffler	Horizontal discharge below frame
Spark Plug Gap	1.0 mm (0.040 in.)

ELECTRICAL

Ignition	Electronic Capacitor Discharge Ignition (CDI)
Type of Starter	Bendix
Charging System	Flywheel Alternator



FUEL SYSTEM

Aspiration Natural
 Fuel Tank Location Rear
 Fuel Tank Capacity 7.5 L (2.0 gal)
 Fuel Type (minimum octane) Unleaded Gasoline, 87 Octane
 Fuel Delivery Float-Type Side Draft Carburetor
 Fuel Filter Replaceable In-Line
 Fuel Filler Opening/Location 7.6 cm (3 in.) Diameter/Left Rear Fender

Battery:

Voltage 12
 BCI group U-1
 CCA rating (Amps At -18°C (0°F)) 160
 Reserve capacity (Minutes At 25 Amps) 20
 Specific gravity (Minimum) 1.225 points
 Electrolyte required fill (Approximate) 1.9 L (2.0 qt)
 Load test (Minimum) 255 amp for 15 seconds

POWER TRAIN SPECIFICATIONS

Gear Transaxle:

Make Dana
 Model Spicer Heavy-Duty 4360 Transaxle
 Type Five-Speed/Linear Shift
 Ground Speeds (At Fast Idle—3350 rpm) and Gear Ratios:
 1st Gear 2.5 km/hr (1.6 mph)—61.67:1
 2nd Gear 3.3 km/hr (2.1 mph)—46.67:1
 3rd Gear 5.2 km/hr (3.2 mph)—30.00:1
 4th Gear 6.6 km/hr (4.1 mph)—23.48:1
 5th Gear 8.5 km/hr (5.3 mph)—18.46:1
 Reverse 3.9 km/hr (2.4 mph)—40.00:1
 Brake Type Single, External Brake Disc With Dual Friction Pucks
 Lubrication—Input Shaft Needle Bearings Unirex® N3 Grease Only (M120263)
 Lubrication—Transaxle Shell Darina® D Grease Only (AM119608)
 Capacity—Transaxle 0.64 kg (1.406 lbs)

Hydrostatic Transaxle:

Drive Train Belt Drive Transaxle with foot-controlled variable speed drive
 Model Tuff Torq® K51 Transaxle
 Travel Speed-Forward 0-8.8 km/h (0-5.5 mph)
 Travel Speed-Reverse 0-4.7 km/h (0-3.0 mph)
 Brake type Single, Internal Wet Disc Brake

PTO Drive:

Type V-Belt
 Clutch Type Mechanical
 Control Lever on Dash

STEERING

Type Sector and Pinion
 Turning Radius 38.1 cm (15 in.)

IMPLEMENT LIFT

Lift System Manual
 Lift Lever Location Left-hand side of hood

TIRES

Size-Front	15 x 6.00 - 6
Size-Rear	20 x 10.00 - 8
Pressure-Front (with mower)	83 kPa (12 psi)
Pressure-Rear (with mower)	55 kPa (8 psi)

NET WEIGHT (NO FUEL)

LT133 with 38" deck	206.8 kg (455 lbs)
LT155 with 38" deck	213.6 kg (470 lbs)
LT155 with 42" deck	215.9 kg (475 lbs)
LT166 with 42" deck	215.9 kg (475 lbs)
LT166 with 46" deck	220.5 kg (485 lbs)

38 INCH MOWER DECK

Type	Rotary - Convertible
Cutting Blade	Two—76 x 5 x 496 mm (3 x 0.2 x 19.5 in.)
Blade Cutting Edge30 ± 5° Angle
Overall Cutting Width	96.5 cm (38 in.)
Cutting Settings	Thirteen: 25—102 mm (1.0—4.0 in.)

42 INCH MOWER DECK

Type	Rotary—Double Spindles, Mulching
Blade Cutting Edge30 ± 5° Angle
Overall Cutting Width	106.8 cm (42 in.)
Cutting Settings	Thirteen: 25—102 mm (1.0—4.0 in.)

46 INCH MOWER DECK

Type	Rotary - Convertible
Cutting Blade	Three—50.8 x 5 x 407.4 mm (2 x 0.2 x 16 in.)
Blade Cutting Edge30 ± 5° Angle
Overall Cutting Width	116.8 cm (46 in.)
Cutting Settings	Thirteen: 25 mm—102 mm (1.0—4.0 in.)

48C INCH MOWER DECK

Type	Rotary - Convertible
Cutting Blade	Three—50.8 x 5 x 407.4 mm (2 x 0.2 x 16 in.)
Blade Cutting Edge30 ± 5° Angle
Overall Cutting Width	121.9 cm (48 in.)
Cutting Settings	Thirteen: 25 mm—102 mm (1.0—4.0 in.)



METRIC FASTENER TORQUE VALUES

Property Class and Head Markings	4.8	8.8	9.8	10.9	12.9
Property Class and Nut Markings	5	10	10	12	

TS1163

SIZE	Class 4.8		Class 8.8 or 9.8				Class 10.9				Class 12.9					
	Lubricated ^a		Dry ^a		Lubricated ^a		Dry ^a		Lubricated ^a		Dry ^a		Lubricated ^a		Dry ^a	
	N•m	lb-ft	N•m	lb-ft	N•m	lb-ft	N•m	lb-ft	N•m	lb-ft	N•m	lb-ft	N•m	lb-ft	N•m	lb-ft
M6	4.8	3.5	6	4.5	9	6.5	11	8.5	13	9.5	17	12	15	11.5	19	14.5
M8	12	8.5	15	11	22	16	28	20	32	24	40	30	37	28	47	35
M10	23	17	29	21	43	32	55	40	63	47	80	60	75	55	95	70
M12	40	29	50	37	75	55	95	70	110	80	140	105	130	95	165	120
M14	63	47	80	60	120	88	150	110	175	130	225	165	205	150	260	109
M16	100	73	125	92	190	140	240	175	275	200	350	225	320	240	400	300
M18	135	100	175	125	260	195	330	250	375	275	475	350	440	325	560	410
M20	190	140	240	180	375	275	475	350	530	400	675	500	625	460	800	580
M22	260	190	330	250	510	375	650	475	725	540	925	675	850	625	1075	800
M24	330	250	425	310	650	475	825	600	925	675	1150	850	1075	800	1350	1000
M27	490	360	625	450	950	700	1200	875	1350	1000	1700	1250	1600	1150	2000	1500
M30	675	490	850	625	1300	950	1650	1200	1850	1350	2300	1700	2150	1600	2700	2000
M33	900	675	1150	850	1750	1300	2200	1650	2500	1850	3150	2350	2900	2150	3700	2750
M36	1150	850	1450	1075	2250	1650	2850	2100	3200	2350	4050	3000	3750	2750	4750	3500

DO NOT use these hand torque values if a different torque value or tightening procedure is given for a specific application. Torque values listed are for general use only and include a ±10% variance factor. Check tightness of fasteners periodically. DO NOT use air powered wrenches.

Shear bolts are designed to fail under predetermined loads. Always replace shear bolts with identical grade.

Fasteners should be replaced with the same class. Make sure fastener threads are clean and that you properly start thread engagement. This will prevent them from failing when tightening.

When bolt and nut combination fasteners are used, torque values should be applied to the **NUT** instead of the bolt head.

Tighten toothed or serrated-type lock nuts to the full torque value.

^a "Lubricated" means coated with a lubricant such as engine oil, or fasteners with phosphate and oil coatings. "Dry" means plain or zinc plated (Yellow Dichromate - Specification JDS117) without any lubrication.











Reference: JDS—G200

METRIC FASTENER TORQUE VALUE—GRADE 7

Size	Steel or Gray Iron Torque		Aluminum Torque	
	N•m	lb-ft	N•m	lb-ft
M6	11	8	8	6
M8	24	18	19	14
M10	52	38	41	30
M12	88	65	70	52
M14	138	102	111	82
M16	224	165	179	132



INCH FASTENER TORQUE VALUES

SAE Grade and Head Markings	1 or 2 ^b No Marks 	5  5.1  5.2 	8  8.2 
	2 No Marks 	5  	8  

TS1162

SIZE	Grade 1				Grade 2 ^b				Grade 5, 5.1 or 5.2				Grade 8 or 8.2			
	Lubricated ^a		Dry ^a		Lubricated ^a		Dry ^a		Lubricated ^a		Dry ^a		Lubricated ^a		Dry ^a	
	N•m	lb-ft	N•m	lb-ft	N•m	lb-ft	N•m	lb-ft	N•m	lb-ft	N•m	lb-ft	N•m	lb-ft	N•m	lb-ft
1/4	3.7	2.8	4.7	3.5	6	4.5	7.5	5.5	9.5	7	12	9	13.5	10	17	12.5
5/16	7.7	5.5	10	7	12	9	15	11	20	15	25	18	28	21	35	26
3/8	14	10	17	13	22	16	27	20	35	26	44	33	50	36	63	46
7/16	22	16	28	20	35	26	44	32	55	41	70	52	80	58	100	75
1/2	33	25	42	31	53	39	67	50	85	63	110	80	120	90	150	115
9/16	48	36	60	45	75	56	95	70	125	90	155	115	175	130	225	160
5/8	67	50	85	62	105	78	135	100	170	125	215	160	215	160	300	225
3/4	120	87	150	110	190	140	240	175	300	225	375	280	425	310	550	400
7/8	190	140	240	175	190	140	240	175	490	360	625	450	700	500	875	650
1	290	210	360	270	290	210	360	270	725	540	925	675	1050	750	1300	975
1-1/8	470	300	510	375	470	300	510	375	900	675	1150	850	1450	1075	1850	1350
1-1/4	570	425	725	530	570	425	725	530	1300	950	1650	1200	2050	1500	2600	1950
1-3/8	750	550	950	700	750	550	950	700	1700	1250	2150	1550	2700	2000	3400	2550
1-1/2	1000	725	1250	925	990	725	1250	930	2250	1650	2850	2100	3600	2650	4550	3350

DO NOT use these hand torque values if a different torque value or tightening procedure is given for a specific application. Torque values listed are for general use only and include a ±10% variance factor. Check tightness of fasteners periodically. DO NOT use air powered wrenches.

Shear bolts are designed to fail under predetermined loads. Always replace shear bolts with identical grade.

Fasteners should be replaced with the same grade. Make sure fastener threads are clean and that you properly start thread engagement. This will prevent them from failing when tightening.

When bolt and nut combination fasteners are used, torque values should be applied to the **NUT** instead of the bolt head.

Tighten toothed or serrated-type lock nuts to the full torque value.

^a "Lubricated" means coated with a lubricant such as engine oil, or fasteners with phosphate and oil coatings. "Dry" means plain or zinc plated (yellow dichromate - Specification JDS117) without any lubrication.

^b "Grade 2" applies for hex cap screws (Not Hex Bolts) up to 152 mm (6-in.) long. "Grade 1" applies for hex cap screws over 152 mm (6-in.) long, and for all other types of bolts and screws of any length.

Reference: JDS—G200

GASOLINE

⚠ CAUTION

Gasoline is **HIGHLY FLAMMABLE**, handle it with care.

DO NOT refuel machine while:

- indoors, always fill gas tank outdoors
- machine is near an open flame or sparks
- engine is running, **STOP** engine
- engine is hot, allow it to cool sufficiently first
- smoking

Help prevent fires:

- fill gas tank to bottom of filler neck only
- be sure fill cap is tight after fueling
- clean up any gas spills **IMMEDIATELY**
- keep machine clean and in good repair—free of excess grease, oil, debris, and faulty or damaged parts
- any storage of machines with gas left in tank should be in an area that is well ventilated to prevent possible igniting of fumes by an open flame or spark, this includes any appliance with a pilot light

To prevent fire or explosion caused by **STATIC ELECTRIC DISCHARGE** during fueling:

- **ONLY** use a clean, approved **POLYETHYLENE PLASTIC** fuel container and funnel **WITHOUT** any metal screen or filter

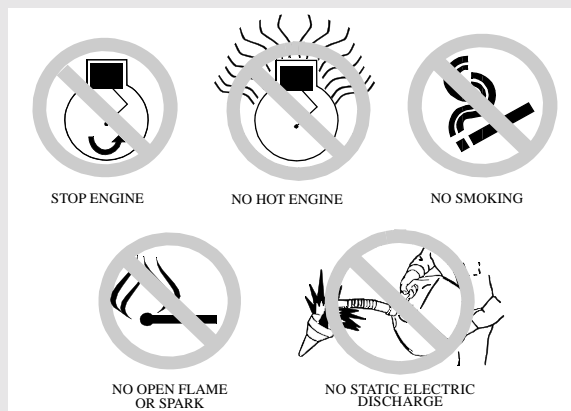

To avoid engine damage:

- DO NOT mix oil with gasoline
- **ONLY** use clean, fresh unleaded gasoline with an octane rating (anti-knock index) of 87 or higher
- fill gas tank at the end of each day's operation to help prevent condensation from forming inside a partially filled tank
- keep up with specified service intervals

Use of alternative oxygenated, gasohol blended, unleaded gasoline is acceptable as long as:

- the ethyl or grain alcohol blends DO NOT exceed 10% by volume or
- methyl tertiary butyl ether (MTBE) blends DO NOT exceed 15% by volume



IMPORTANT: DO NOT use **METHANOL** gasolines because **METHANOL** is harmful to the environment and to your health.

⚠ WARNING

California Proposition 65 Warning: Gasoline engine exhaust from this product contains chemicals known to the State of California to cause cancer, birth defects, or other reproductive harm.

GASOLINE STORAGE

IMPORTANT: Keep all dirt, scale, water or other foreign material out of gasoline.

Keep gasoline stored in a safe, protected area. Storage of gasoline in a clean, properly marked ("**UNLEADED GASOLINE**") **POLYETHYLENE PLASTIC** container **WITHOUT** any metal screen or filter is recommended. **DO NOT** use de-icers to attempt to remove water from gasoline or depend on fuel filters to remove water from gasoline. Use a water separator installed in the storage tank outlet. **BE SURE** to properly discard unstable or contaminated gasoline. When storing unit or gasoline, it is recommended that you add **John Deere Gasoline Conditioner and Stabilizer (TY15977)** or an equivalent to the gasoline. **BE SURE** to follow directions on container and to properly discard empty container.

LUBRICANTS

ENGINE OIL - KOHLER ENGINE

Use the appropriate oil viscosity based on the expected air temperature range during the period between recommended oil changes. Operating outside of these recommended oil air temperature ranges may cause premature engine failure.

The following John Deere oil is **PREFERRED**:

- **PLUS-4[®]—SAE 10W-40**
- **TURF-GARD[®]—SAE 10W-30**

The following John Deere oils are **also recommended**, based on their specified temperature range:

- **TORQ-GARD SUPREME[®]—5W-30**

Other oils may be used if above John Deere oils are not available, provided they meet one of the following specifications:

- SAE 5W-30—API Service Classification SJ or higher;
- SAE 10W-30—API Service Classification SJ or higher;
- SAE 30—API Service Classification SJ or higher.
- CCMC Specification G4 or higher.

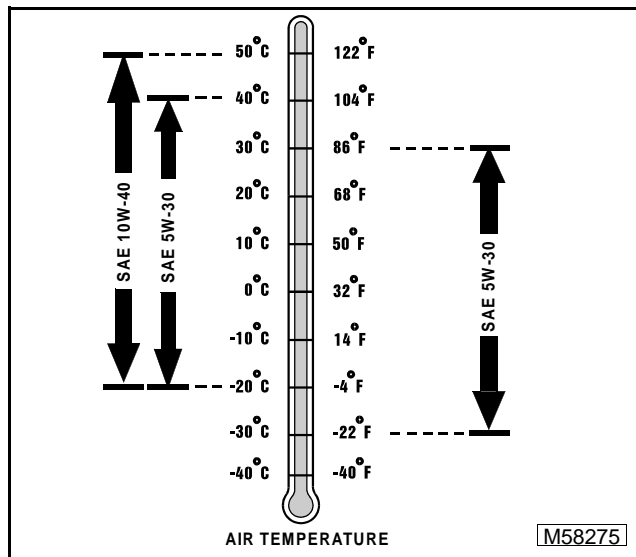

John Deere Dealers: You may want to cross-reference the following publications to recommend the proper oil for your customers:

- Module DX, ENOIL2 in JDS-G135;
- Section 530, Lubricants & Hydraulics, of the John Deere Merchandise Sales Guide;
- Lubrication Sales Manual PI7032.

ENGINE OIL - BRIGGS & STRATTON ENGINE

Use the appropriate oil viscosity based on the expected air temperature range during the period between recommended oil changes. Operating outside of these recommended oil air temperature ranges may cause premature engine failure.

The following John Deere oils are **PREFERRED**, based on their specified temperature range:

- **TURF-GARD[®]—SAE 10W-30**
- **PLUS-4[®]—SAE 10W-30**
- **TORQ-GARD SUPREME[®]—SAE30**

Other oils may be used if above John Deere oils are not available, provided they meet one of the following specifications:

- SAE 5W-30—API Service Classification SJ or higher;
- SAE 10W-30—API Service Classification SJ or higher;
- SAE 30—API Service Classification SJ or higher.
- CCMC Specification G4 or higher.

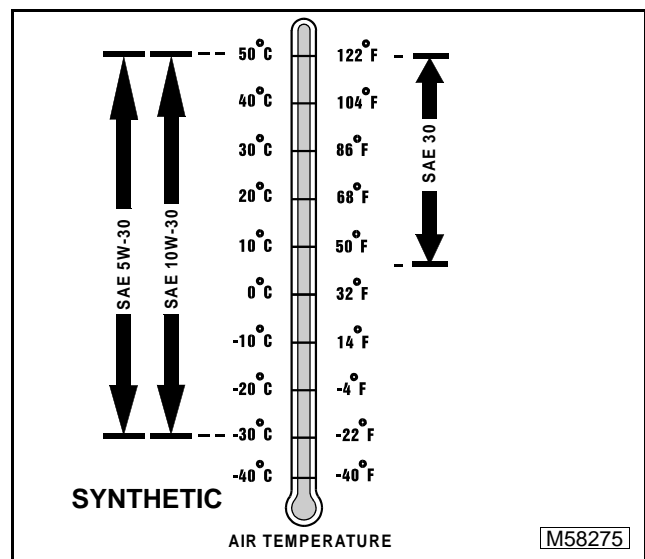

John Deere Dealers: You may want to cross-reference the following publications to recommend the proper oil for your customers:

- Module DX, ENOIL2 in JDS-G135;
- Section 530, Lubricants & Hydraulics, of the John Deere Merchandise Sales Guide;
- Lubrication Sales Manual PI7032.

ENGINE BREAK-IN OIL

IMPORTANT: ONLY use a quality break-in oil in rebuilt or remanufactured engines for the first 5 hours (maximum) of operation. DO NOT use oils with heavier viscosity weights than SAE 5W-30 or oils meeting specifications API SG or SH, these oils will not allow rebuilt or remanufactured engines to break-in properly.

The following John Deere oil is **PREFERRED**:

- **BREAK-IN ENGINE OIL.**

John Deere BREAK-IN ENGINE OIL is formulated with special additives for aluminum and cast iron type engines to allow the power cylinder components (pistons, rings, and liners as well) to “wear-in” while protecting other engine components, valve train and gears, from abnormal wear. Engine rebuild instructions should be followed closely to determine if special requirements are necessary.

John Deere BREAK-IN ENGINE OIL is also recommended for non-John Deere engines, both aluminum and cast iron types.

The following John Deere oil is **also recommended** as a break-in engine oil:

- **TORQ-GARD SUPREME®—SAE 5W-30.**

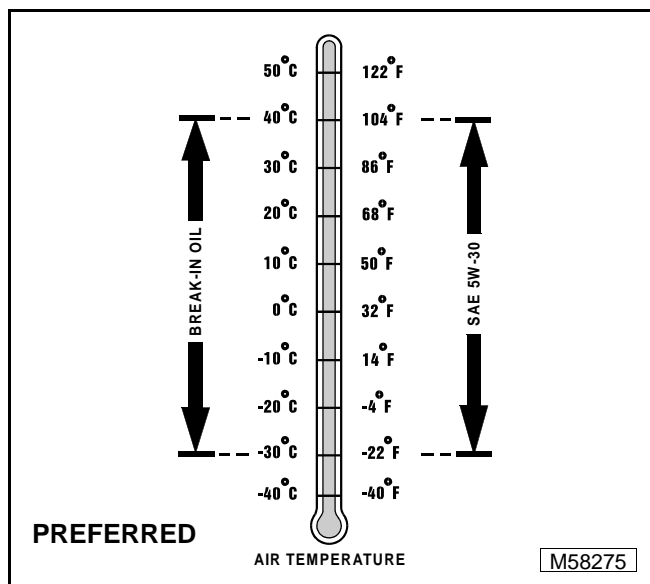

If the above recommended John Deere oils are not available, use a break-in engine oil meeting the following specification during the first 5 hours (maximum) of operation:

- SAE 5W-30—API Service Classification SJ or higher.

- SAE 5W-30—CCMC Specification G4 or higher.

IMPORTANT: After the break-in period, use the John Deere oil that is recommended for this engine.

John Deere Dealers: You may want to cross-reference the following publications to recommend the proper oil for your customers:

- Module DX, ENOIL4 in JDS-G135;
- Section 530, Lubricants & Hydraulics, of the John Deere Merchandise Sales Guide;
- Lubrication Sales Manual PI7032.

ANTI-CORROSION GREASE

This anti-corrosion grease is formulated to provide the best protection against absorbing moisture, which is one of the major causes of corrosion. This grease is also superior in its resistance to separation and migration.

The following anti-corrosion grease is **PREFERRED**:

- **DuBois MPG-2® Multi-Purpose Polymer Grease—M79292.**

Other greases may be used if they meet or exceed the following specifications:

- John Deere Standard JDM J13A2, NLGI Grade 1.

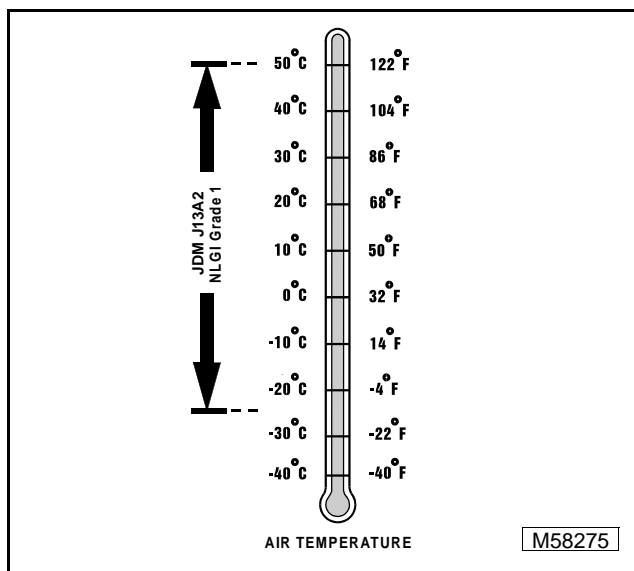

John Deere Dealers: You may want to cross-reference the following publications to recommend the proper grease for your customers:

- Module DX, GRE A1 in JDS-G135;
- Section 530, Lubricants & Hydraulics, of the John Deere Merchandise Sales Guide;
- Lubrication Sales Manual PI7032.

ALTERNATIVE LUBRICANTS

Conditions in certain geographical areas outside the United States and Canada may require different lubricant recommendations than the ones printed in this technical manual or the operator's manual. Consult with your John Deere Dealer, or Sales Branch, to obtain the alternative lubricant recommendations.

IMPORTANT: Use of alternative lubricants could cause reduced life of the component.

If alternative lubricants are to be used, it is recommended that the factory fill be thoroughly removed before switching to any alternative lubricant.

SYNTHETIC LUBRICANTS

Synthetic lubricants may be used in John Deere equipment if they meet the applicable performance requirements (industry classification and/or military specification) as shown in this manual.

The recommended air temperature limits and service or lubricant change intervals should be maintained as shown in the operator's manual.

Avoid mixing different brands, grades, or types of oil. Oil manufacturers blend additives in their oils to meet certain specifications and performance requirements. Mixing different oils can interfere with the proper functioning of these additives and degrade lubricant performance.

LUBRICANT STORAGE

All machines operate at top efficiency only when clean lubricants are used. Use clean storage containers to handle all lubricants. Store them in an area protected from dust, moisture, and other contamination. Store drums on their sides. Make sure all containers are properly marked as to their contents. Dispose of all old, used containers and their contents properly.

MIXING OF LUBRICANTS

In general, avoid mixing different brands or types of lubricants. Manufacturers blend additives in their lubricants to meet certain specifications and performance requirements. Mixing different lubricants can interfere with the proper functioning of these additives and lubricant properties which will downgrade their intended specified performance.

CHASSIS GREASE

Use the following grease based on the air temperature range. Operating outside of the recommended grease air temperature range may cause premature failures.

IMPORTANT: ONLY use a quality grease in this application. DO NOT mix any other greases in this application. DO NOT use any BIO-GREASE in this application.

The following John Deere grease is **PREFERRED**:

- **HIGH-TEMPERATURE EP GREASE®—JDM J13E4, NLGI Grade 2.**
- **GREASE-GARD™—JDM J13E4, NLGI Grade 2.**

Other greases may be used if above preferred John Deere grease is not available, provided they meet the following specification:

- John Deere Standard JDM J13E4, NLGI Grade 2.

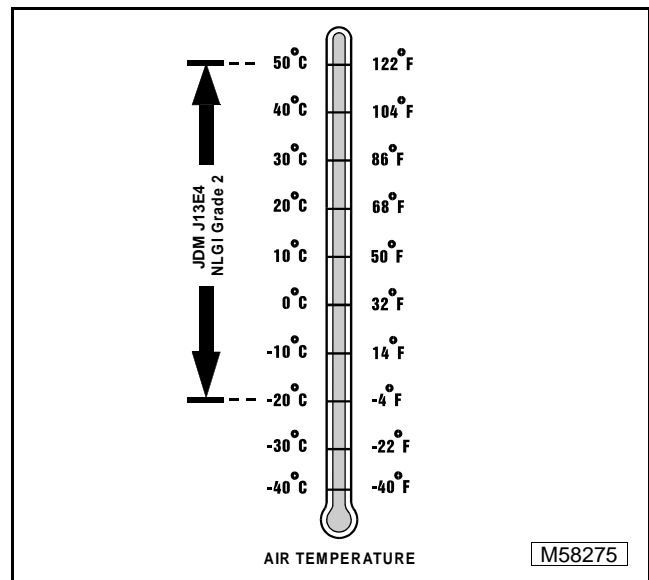

John Deere Dealers: You may want to cross-reference the following publications to recommend the proper grease for your customers:

- Module DX,GREA1 in JDS-G135;
- Section 530, Lubricants & Hydraulics, of the John Deere Merchandise Sales Guide;
- Lubrication Sales Manual P17032.

GEAR TRANSMISSION GREASE

Use the following gear grease based on the air temperature range. Operating outside of the recommended grease air temperature range may cause premature gear case failure.

IMPORTANT: ONLY use a quality greases in this gear case. DO NOT mix any other greases in this gear case. DO NOT use any BIO-HY-GARD® in this gear case.

ONLY use the following PREFERRED grease as the input shaft needle bearing lubricant:

- Unirex N3 Grease®—M120263

Other greases may be used as the input shaft needle bearing lubricant if they meet or exceed the following specification:

- ASTM D-1743, NLGI Grade 1

ONLY use the following PREFERRED grease as the gear housing lubricant:

- Shell Darina D Grease®—AM119608

Other greases may be used as the gear housing lubricant if they meet or exceed the following specification:

- ASTM D-1743, NLGI Grade 1

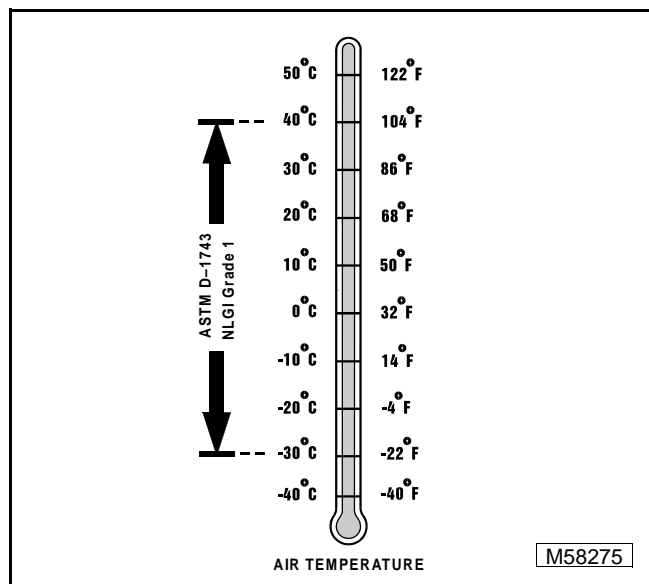

HYDROSTATIC TRANSMISSION OIL

Use the appropriate oil viscosity based on these air temperature ranges. Operating outside of these recommended oil air temperature ranges may cause premature hydrostatic transmission failure.

IMPORTANT: ONLY use a quality 10W-30 SYNTHETIC engine oil in this transmission. Mixing of two viscosity grade oils is NOT RECOMMENDED. DO NOT use BIO-HY-GARD® in this transmission.

The following oil is RECOMMENDED:

- TURF-GARD® 10W-30
- PLUS4® 10W-30

Use only oils that meet the following specifications:

- API Service Classifications SG or higher.
- CCMC Specifications G4 or higher.

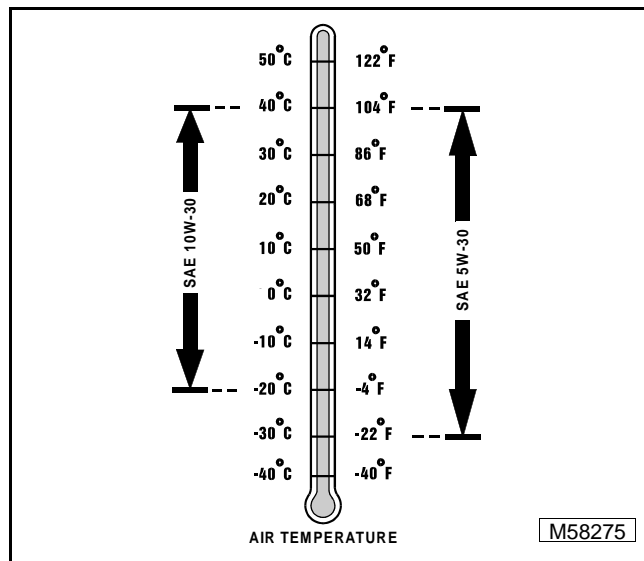

John Deere Dealers: You may want to cross-reference the following publications to recommend the proper oil for your customers:

- Module DX, ENOIL2 in JDS-G135;
- Section 530, Lubricants & Hydraulics, of the John Deere Merchandise Sales Guide;
- Lubrication Sales Manual PI7032.

SERIAL NUMBER LOCATION

When ordering parts or submitting a warranty claim, it is **IMPORTANT** that the machine product identification number (PIN) and component serial numbers are included. The location of the PIN and component serial numbers are shown.



Machine Product Identification Number

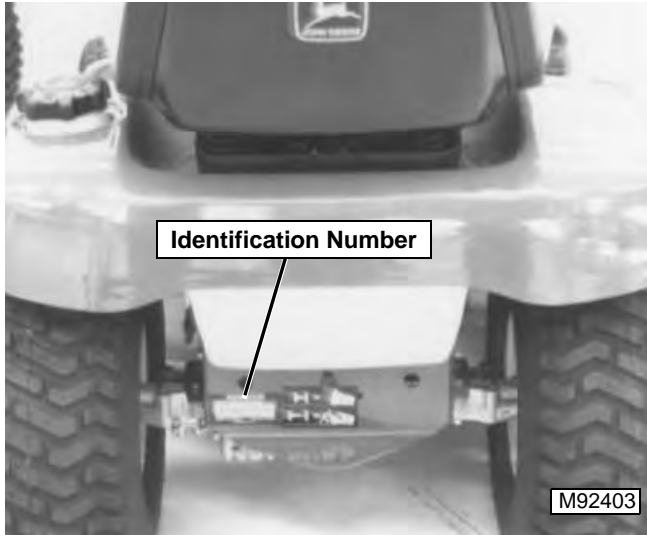

(S/N -125000)

(S/N 125001-) Located below front of operators seat.

Engine Serial Number—LT133/LT155

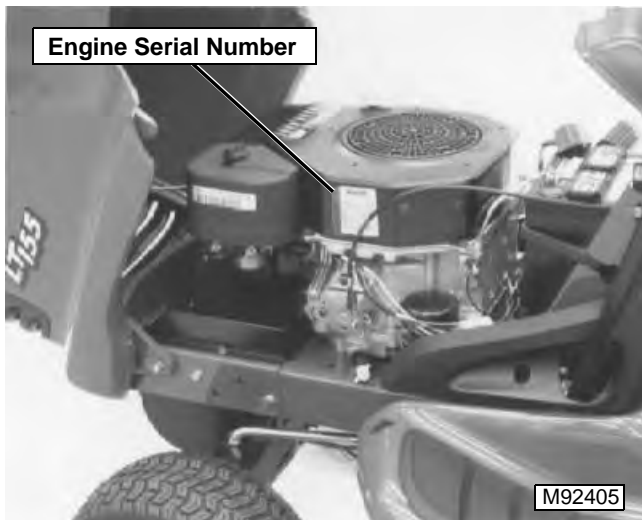

Engine Serial Number—LT166

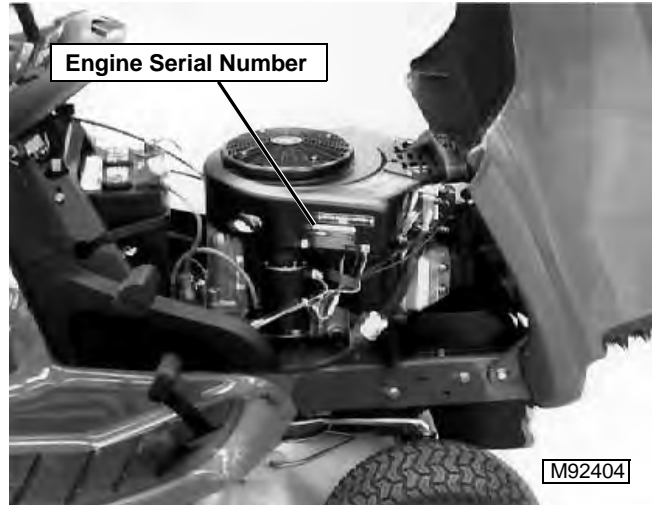

Transaxle Serial Number



CONTENTS

	Page
SPECIFICATIONS	3
GENERAL SPECIFICATIONS—LT133 (13 hp) & LT 155 (15 hp)	3
TESTS & ADJUSTMENTS SPECIFICATIONS	3
REPAIR SPECIFICATIONS	4
TORQUE SPECIFICATIONS (Alphabetical)	7
SPECIAL OR REQUIRED TOOLS	8
TROUBLESHOOTING	9
ENGINE TROUBLESHOOTING	11
TESTS AND ADJUSTMENTS	14
THROTTLE CABLE ADJUSTMENT	14
CHOKE ADJUSTMENT	14
GOVERNOR ADJUSTMENT	15
FAST IDLE SPEED ADJUSTMENT	15
SLOW IDLE SPEED ADJUSTMENT	16
CYLINDER LEAK TEST	16
AUTOMATIC COMPRESSION RELEASE (ACR) CHECK	17
CRANKCASE VACUUM TEST	17
FUEL FLOW TEST	19
OIL PRESSURE TEST	20
FUEL & AIR REPAIR	21
AIR INTAKE SYSTEM COMPONENTS	21
CARBURETOR REMOVAL/INSTALLATION	22
CARBURETOR INSPECTION	22
ENGINE REPAIR	24
FUEL PUMP REMOVAL/INSTALLATION	24
ENGINE REMOVAL/INSTALLATION	24
ROCKER ARMS REMOVAL/INSTALLATION	26
CYLINDER HEAD REMOVAL/INSTALLATION	27
VALVES AND SPRINGS REMOVAL/INSTALLATION	27
CYLINDER HEAD INSPECTION	28
VALVES INSPECTION	28
VALVE GUIDES INSPECTION	28
VALVE SEATS RECONDITION	29
VALVES LAP	30
BREATHER INSPECTION	30
FLYWHEEL REMOVAL/INSTALLATION	30
CAMSHAFT REMOVAL/INSTALLATION	31
CAMSHAFT INSPECTION	31
CAMSHAFT END PLAY MEASUREMENT	32
HYDRAULIC VALVE LIFTERS REMOVAL/INSTALLATION	32
HYDRAULIC VALVE LIFTERS INSPECTION	33
BALANCER SHAFT REMOVAL/INSTALLATION	34
BALANCER SHAFT INSPECTION	34
GOVERNOR REMOVAL/INSTALLATION	35





	Page
GOVERNOR INSPECTION	35
PISTON ASSEMBLY REMOVAL	36
PISTON ASSEMBLY DISASSEMBLE	36
PISTON INSPECTION	36
PISTON RING END GAP MEASUREMENT	37
PISTON RING SIDE CLEARANCE MEASUREMENT	37
PISTON ASSEMBLY MEASUREMENT	38
PISTON ASSEMBLY	39
PISTON INSTALLATION	39
CRANKSHAFT REMOVAL/INSTALLATION	40
CRANKSHAFT AND MAIN BEARING INSPECTION	40
CRANKSHAFT ALIGNMENT	41
OIL PAN REMOVAL/INSTALLATION	41
OIL PAN SEAL REMOVAL/INSTALLATION	42
CRANKCASE OIL SEAL REMOVAL/INSTALLATION	43
OIL PICKUP INSPECTION	43
OIL PUMP RELIEF VALVE INSPECTION	43
OIL PUMP INSTALLATION	44
CYLINDER BLOCK REMOVAL/INSTALLATION	44
CYLINDER BLOCK INSPECTION	44
CYLINDER BORE DEGLAZING	45
STATOR & IGNITION MODULE REMOVAL/INSTALLATION	45
STARTING MOTOR REMOVAL/INSTALLATION	46
STARTING MOTOR DRIVE REPLACEMENT	46
STARTING MOTOR BRUSH REPLACEMENT & ARMATURE TEST	47

SPECIFICATIONS

GENERAL SPECIFICATIONS—LT133 (13 hp) & LT 155 (15 hp)

Make	Kohler
Model / Model Number:	
LT133	Command LT / CV13S-21525
LT155	Command 15 QT / CV15S-41562
Power:	
LT133	9.7 kW (13.0 hp)
LT155	11.2 kW (15.0 hp)
Displacement:	
LT133	.398 cm ³ (24.3 cu-in.)
LT155	.426 cm ³ (26.0 cu-in.)
Cylinders	1
Stroke/Cycle	4
Valves	Overhead Valves
Bore:	
LT133	87 mm (3.43 in.)
LT155	90 mm (3.60 in.)
Stroke (All)	67 mm (2.64 in.)
Compression Ratio	2:1 Cranking—8.5:1 Running
Compression Release	Automatic/Centrifugal
Crankshaft Type	Vertical (counterbalanced)
Lubrication	Pressurized Gerotor Pump 0—413 kPa (0—60 psi)
Oil Filter	Single Element, Full Flow, Spin-On Filter
Crankcase Capacity (With Filter)	1.8 L (1.9 qt)
Without Filter	1.4 L (1.5 qt)
Cooling System	Air Cooled
Air Cleaner	Paper with outer foam element
Muffler	Horizontal discharge below frame
Slow Idle	1700 ± 25 rpm
Fast Idle (Domestic)	3400 ± 25 rpm
Maximum Angle of Operation (With Full Crankcase):	
Continuous (All Directions)	.20°
Intermittent (All Directions)	.35°
Fuel Filter	Replaceable (In-Line Type)
Fuel Shut-Off Solenoid (Optional)	Replaceable (Below Carburetor Float Bowl)
Weight	39.54 kg (87 lbs)



TESTS & ADJUSTMENTS SPECIFICATIONS

Engine:

Spark Plug Gap	1.0 mm (0.040 in.)
Valve Adjustment	None (hydraulic lifters)
Oil Pressure (Minimum at 1250 rpm)	124 kPa (18 psi)
Crankcase Vacuum (Minimum At Operating Temp.)	102 mm (4 in.) Water Movement
Automatic Compression Release Minimum Lift (Engine Cold)	0.25 mm (0.01 in.)

Fuel/Air System:

Carburetor Slow Idle Mixture Screw Initial Setting	Lightly Seat, Then 1 Turn Out
Slow Idle Speed	1700 ± 25 rpm
Fast Idle Speed	3400 ± 25 rpm

REPAIR SPECIFICATIONS

Cylinder Head:

Cylinder Head Flatness (Maximum Warp) 0.076 mm (0.003 in.)

Push Rod:

Maximum Bend 0.76 mm (0.030 in.)

Valves and Valve Lifters:

Hydraulic Lifter Clearance 0.0124—0.0501 mm (0.0005—0.0020 in.)

Intake Valve-to-Guide Clearance 0.038—0.076 mm (0.0015—0.0030 in.)

Intake Valve Stem OD 6.982—7.000 mm (0.2749—0.2756 in.)

Exhaust Valve Stem OD 6.970—6.988 mm (0.2744—0.2751 in.)

Exhaust Valve-to-Guide Clearance 0.050—0.088 mm (0.0020—0.0035 in.)

Intake Valve Guide ID:

New 7.038—7.058 mm (0.2771—0.2779 in.)

Maximum 7.134 mm (0.2809 in.)

Exhaust Valve Guide ID:

New 7.038—7.058 mm (0.2771—0.2779 in.)

Maximum 7.159 mm (0.2819 in.)

Valve Guide Reamer:

Standard 7.048 mm (0.2775 in.)

Oversize (0.25 mm) 7.298 mm (0.2873 in.)

Intake Valve Lift (Minimum—Engine Cold) 8.96 mm (0.353 in.)

Exhaust Valve Lift (Minimum—Engine Cold) 9.14 mm (0.360 in.)

Valve Face Angle 45°

Valve Seat Angle 44.5°

Rocker Arms:

Rocker Arm ID

New 15.837—16.127 mm (0.63—0.64 in.)

Wear Limit 15.727 mm (0.619 in.)

Rocker Shaft:

Rocker Shaft OD

New 15.837—16.127 mm (0.63—0.64 in.)

Wear Limit 15.727 mm (0.619 in.)

Crankshaft:

End Play 0.0575—0.4925 mm (0.0023—0.0194 in.)

Crankshaft Bore ID (Crankcase Half):

New 44.965—45.003 mm (1.7703—1.7718 in.)

Maximum 45.016 mm (1.7723 in.)

Clearance (New) 0.03—0.09 mm (0.0012—0.0035 in.)

Crankshaft Bore (Oil Pan Half):

New 44.965—45.003 mm (1.7703—1.7718 in.)

Maximum 45.016 mm (1.7723 in.)

Clearance (New) 0.03—0.09 mm (0.0012—0.0035 in.)

Main Bearing Journal OD (Flywheel End):

New 44.913—44.935 mm (1.7682—1.7691 in.)

Minimum 44.84 mm (1.765 in.)

Maximum Taper 0.022 mm (0.0009 in.)

Maximum Out-of-Round 0.025 mm (0.0010 in.)

Main Bearing Journal OD (Oil Pan End):

New	41.915—41.935 mm (1.6502—1.6510 in.)
Minimum	41.86 mm (1.648 in.)
Maximum Taper	0.020 mm (0.0008 in.)
Maximum Out-of-Round	0.025 mm (0.0010 in.)

Connecting Rod Journal OD:

New	38.958—38.970 mm (1.5338—1.5343 in.)
Minimum	38.94 mm (1.5328 in.)
Maximum Taper	0.012 mm (0.0005 in.)
Maximum Out-of-Round	0.025 mm (0.0010 in.)

Crankshaft Total Indicated Runout (TIR):

PTO End (In Engine)	0.15 mm (0.0059 in.)
Entire Crankshaft (In Bench V-Blocks)	0.10 mm (0.0039 in.)

Camshaft:

End Play (with shims)	0.076—0.127 mm (0.003—0.005 in.)
Clearance	0.025—0.063 mm (0.0010—0.0025 in.)
Bore ID:	
New	20.000—20.025 mm (0.7874—0.7884 in.)
Maximum	20.038 mm (0.7889 in.)
Bearing OD:	
New	19.962—19.975 mm (0.7859—0.7864 in.)
Minimum	19.959 mm (0.7858 in.)

Balance Shaft:

End Play	0.0575—0.3625 mm (0.0023—0.0143 in.)
Clearance	0.025—0.063 mm (0.0009—0.0025 in.)
Bore ID:	
New	20.000—20.025 mm (0.7874—0.7884 in.)
Maximum	20.038 mm (0.7889 in.)
Balance Shaft Bearing OD:	
New	19.962—19.975 mm (0.7859—0.7864 in.)
Minimum	19.959 mm (0.7858 in.)

Cylinder Bore, Piston and Rings:

Cylinder Bore ID: (13 hp)	
New	87.000—87.025 mm (3.4252—3.4262 in.)
Maximum	87.063 mm (3.4277 in.)
Cylinder Bore ID: (15 hp)	
New	90.000—90.025 mm (3.5433—3.5443 in.)
Maximum	90.63 mm (3.5681 in.)
Maximum Out-of-Round	0.12 mm (0.0047 in.)
Maximum Taper	0.05 mm (0.0020 in.)
Piston-To-Pin Clearance	0.006—0.017 mm (0.0002—0.0007 in.)
Piston Pin Bore ID:	
New	19.006—19.012 mm (0.7483—0.7485 in.)
Maximum	19.025 mm (0.7490 in.)
Piston Pin OD:	
New	18.995—19.000 mm (0.7478—0.7480 in.)
Minimum	18.994 mm (0.74779 in.)
Top Compression Ring-To-Groove Side Clearance	
13 hp	0.040—0.105 mm (0.0016—0.0041 in.)
15 hp	0.060—0.105 mm (0.0023—0.0041 in.)
Middle Compression Ring-To-Groove Side Clearance	
13 hp	0.040—0.072 mm (0.0016—0.0028 in.)
15 hp	0.040—0.085 mm (0.0015—0.0033 in.)



Oil Control Ring-To-Groove Side Clearance	
13 hp	0.551—0.675 mm (0.0217—0.0266 in.)
15 hp	0.176—0.026 mm (0.0069—0.0010 in.)
Top and Center Compression Ring End Gap	
New Bore:	
13 hp	0.3—0.5 mm (0.012—0.020 in.)
15 hp	0.27—0.51 mm (0.010—0.020 in.)
Used Bore (Maximum)	
All	0.77 mm (0.030 in.)
Piston Thrust Face OD:	
New:	
13 hp	86.941—86.959 mm (3.4229—3.4236 in.)
15 hp	89.951—89.969 mm (3.5413—3.5420 in.)
Minimum:	
13 hp	86.814 mm (3.4179 in.)
15 hp	89.824 mm (3.5363 in.)
Piston Thrust Face-To-Cylinder Bore Clearance	
New:	
13 hp	0.041—0.044 mm (0.0016—0.0017 in.)
15 hp	0.031—0.043 mm (0.0012—0.0016 in.)

Connecting Rod:

Crankshaft (Big End) Clearance	
New	0.030—0.055 mm (0.0012—0.0022 in.)
Maximum	0.07 mm (0.0025 in.)
Side	0.18—0.41 mm (0.007—0.016 in.)
Piston Pin Clearance	0.015—0.028 mm (0.0006—0.0011 in.)
Piston Pin End ID:	
New	19.015—19.023 mm (0.7486—0.7489 in.)
Maximum	19.036 mm (0.7495 in.)

Governor:

Crankcase Control Arm Bore ID:	
New	6.025—6.050 mm (0.2372—0.2382 in.)
Maximum	6.063 mm (0.2387 in.)
Control Arm OD:	
New	5.975—6.000 mm (0.2352—0.2362 in.)
Minimum	5.962 mm (0.2347 in.)
Crankcase Bore-To-Control Arm Clearance . . .	0.025—0.075 mm (0.0010—0.0030 in.)
Gear Shaft OD:	
New	5.990—6.000 mm (0.2358—0.2362 in.)
Minimum	5.977 mm (0.2353 in.)
Gear Shaft-To- Gear Bore Clearance	0.015—0.140 mm (0.0006—0.0055 in.)



TORQUE SPECIFICATIONS (Alphabetical)

NOTE: Use appropriate torque wrench which will read within the inch pound range given, or convert inch pounds to foot pounds as follows: Inch-pounds ÷ 12 = Foot-pounds

Air Cleaner Base Nut	10 N•m (88 lb-in.)
Cylinder Head Cap Screw	41 N•m (30 lb-ft)
Connecting Rod Cap Screws:	
8 mm Straight Shank Bolt	22 N•m (200 lb-in.)
Step Down Shank Bolt	14 N•m (130 lb-in.)
6 mm Straight Shank Bolt	11 N•m (100 lb-in.)
Engine Mounting Cap Screws	32 N•m (24 lb-ft)
Fan Cap Screw	10 N•m (88 lb-in.)
Flywheel Cap Screw	68 N•m (50 lb-ft)
Fuel Pump/Cover Screw:	
New Installation (Thread Forming)	9.0 N•m (80 lb-in.)
Replacement	7 N•m (65 lb-in.)
Fuel Bowl Nut	4 N•m (35 lb-in.)
Governor Control Panel Screw	10 N•m (88 lb-in.)
Ignition Module Screw	
New Installation (Thread Forming)	6 N•m (55 lb-in.)
Replacement	4 N•m (35 lb-in.)
Muffler Nut	24 N•m (216 lb-in.)
Oil Filter	7 N•m (65 lb-in.)
Oil Filter Drain Plug	8 N•m (72 lb-in.)
Oil Pan Cap Screw	24 N•m (216 lb-in.)
Oil Pump Cover Screw	
New Installation (Thread Forming)	6 N•m (55 lb-in.)
Replacement	4 N•m (35 lb-in.)
Rocker Arm Pivot Cap Screw	14 N•m (124 lb-in.)
Spark Plug	40 N•m (30 lb-ft)
Stator Cap Screw	4 N•m (35 lb-in.)
Valve Cover Cap Screw	
New Installation (Thread Forming)	11 N•m (95 lb-in.)
Replacement	7 N•m (65 lb-in.)



SPECIAL OR REQUIRED TOOLS

Tool	Purpose
JDG705 Reaming Tool	Valve guide
 6.4 mm (0.25 in.) Drill Bit	Throttle and choke adjustment
Dial Indicator	Automatic compression relief test, Valve inspection
JT05719 Photo Tachometer	Slow idle adjustment
JT035029 Cylinder Leak Tester	Cylinder leak test
JT05697 U-Tube Manometer Test Kit; or, JT03503 Crankcase Vacuum Test Kit	Crankcase vacuum check
JT07262 Oil Pressure Test Adapter w/ O- ring (required ONLY on engines without test ports)	Oil pressure test
JT05847 Connector	
JT03017 Hose Assembly	
JT03262 Coupler	
JT07034 Gauge, 0 – 700 kPa (0 – 100 psi)	
Lapping Tool	Valve lapping

TROUBLESHOOTING

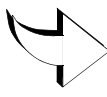
<div style="display: flex; justify-content: space-between; align-items: center;"> <div style="text-align: center;"> <p>Check or Solution</p>  </div> <div style="text-align: center;"> <p>Problem or Symptom</p>  </div> </div>	Engine cranks but will not start or starts hard	Engine will not stay running or runs rough	Engine stalls frequently	Engine backfires	Engine surges, uneven or uncontrolled rpm	Engine misses	Low power under load	Engine has no spark	Engine will not crank	Exhaust black, engine floods or burns rich	Exhaust smoke blue or high oil consumption	Engine has low oil pressure	Fuel in oil	Engine overheats	Excessive engine noise or vibration
Spark plug fouled or incorrect gap. Incorrect spark plug.	●	●	●		●	●	●	●		●			●	●	
Defective ignition components.	●	●	●	●	●	●	●	●	●	●			●		
Starter worn. Cranking rpm too slow, cables corroded, battery weak. Engine overloaded.	●	●	●				●		●			●		●	●
Fuel tank outlet restricted, shut-off valve not fully open, fuel filter or line restricted. Fuel stale, contains water, or wrong type.	●	●	●		●	●	●			●	●				
Air filter element plugged or oil soaked.	●	●	●		●	●	●			●			●		
Choke, throttle, or governor linkage worn / out of adjustment. Carburetor set too rich.	●	●	●	●	●	●	●		●	●			●	●	
Carburetor worn, contaminated with debris or varnish. Passages plugged. Wrong jets or adjusted too lean.	●	●	●	●	●	●	●						●		
Carburetor, intake manifold, or cylinder head gaskets leaking.	●	●	●	●	●	●	●							●	●
Low compression: worn piston, rings, cylinder, valves. Warped head.	●	●	●		●	●	●				●	●	●	●	●
Valve clearance incorrect. Burned or warped valves and seats. Defective springs.	●	●	●	●	●	●	●							●	●
Engine oil viscosity or level incorrect. Engine oil filter restricted. Oil pump worn or passages obstructed.	●	●					●		●			●		●	●
Engine gaskets or seals leaking.	●	●	●	●	●	●	●				●	●	●	●	●
Crankcase breather restricted, reed valve damaged, clearance incorrect, or drain hole plugged.	●	●	●		●	●	●		●		●	●		●	
Valve guides or seals worn or leaking. Valve stems worn.	●	●	●	●	●	●	●				●			●	●
Worn, stuck, or broken piston rings. Cylinder bore worn. Check compression and vacuum.	●	●	●	●	●	●	●				●	●	●	●	●
Connecting rod or crankshaft bearings worn. Internal wear limits out of specification.	●	●	●		●	●	●					●		●	●
Engine mounting hardware loose or broken.					●	●									●



TROUBLESHOOTING (Continued)



<div style="text-align: center;"> <p>Problem or Symptom</p> </div> <div style="text-align: center;"> <p>Check or Solution</p> </div>	Fuel overflows carburetor vent	Engine stops when hot	Engine races or runs one speed	Engine clatters	Engine won't run	White smoke on start-up	Engine runs slow & clicks	Engine runs on after shutdown	Engine won't shut off
Dirt in carburetor. Float sticking Clean carb, replace filter, check float	●								
Vapor lock. Check temperature of fuel system. Clear vent in top of fuel cap		●			●				
Fuel shutoff valve closed					●				
Move governor shaft with engine running, check for resistance			●						
Lifter is collapsed				●	●				
Lifter is stuck in bore				●	●				
Water in fuel bowl of carburetor					●	●			
Engine RPM too low; automatic compression release still on Adjust low idle speed				●			●		
Inspect ignition switch and ground								●	●
Inspect engine ground cable								●	●
Adjust idle speed to specs. Move throttle to idle before shutdown								●	
Inspect piston, valves, cylinder head & exhaust for high carbon build-up								●	

ENGINE TROUBLESHOOTING

Engine Will Not Crank

NOTE: To test specific electrical components, see Electrical Section and refer to either Diagnostics or Tests & Adjustments for further guidance.



CAUTION

BE AWARE! The engine may start to rotate at any time. Keep hands away from all moving parts when testing.

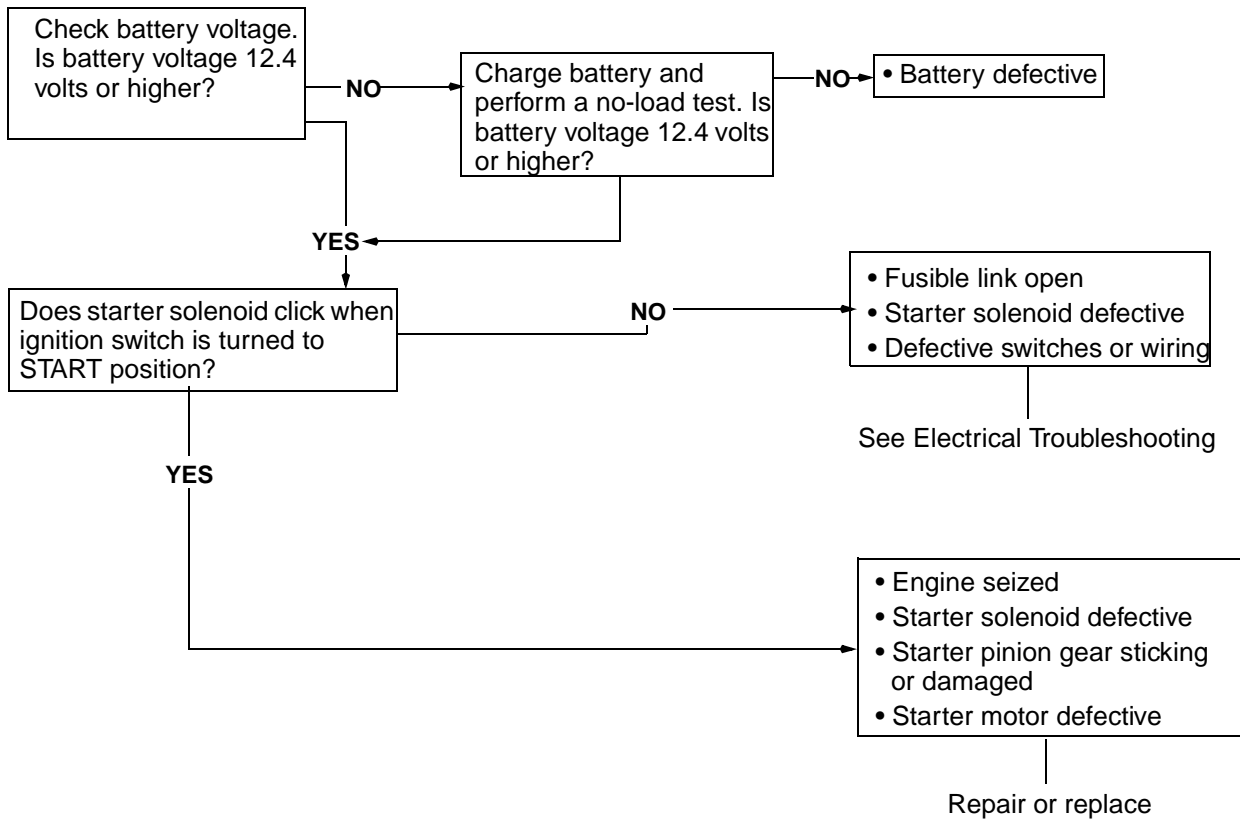

Engine Cranks But Will Not Start

CAUTION

DO NOT rotate engine with starter if the spark plugs are removed. Gasoline spray from the open cylinders may be ignited by ignition spark and cause an explosion or fire.

IMPORTANT: Perform a visual inspection first to determine if battery cables are tight and not corroded and if the battery is of sufficient size to turn the engine over at minimum cranking speed of 350 rpm.

To test specific electrical components, see Electrical Section and refer to either Diagnostics or Tests & Adjustments for further guidance.

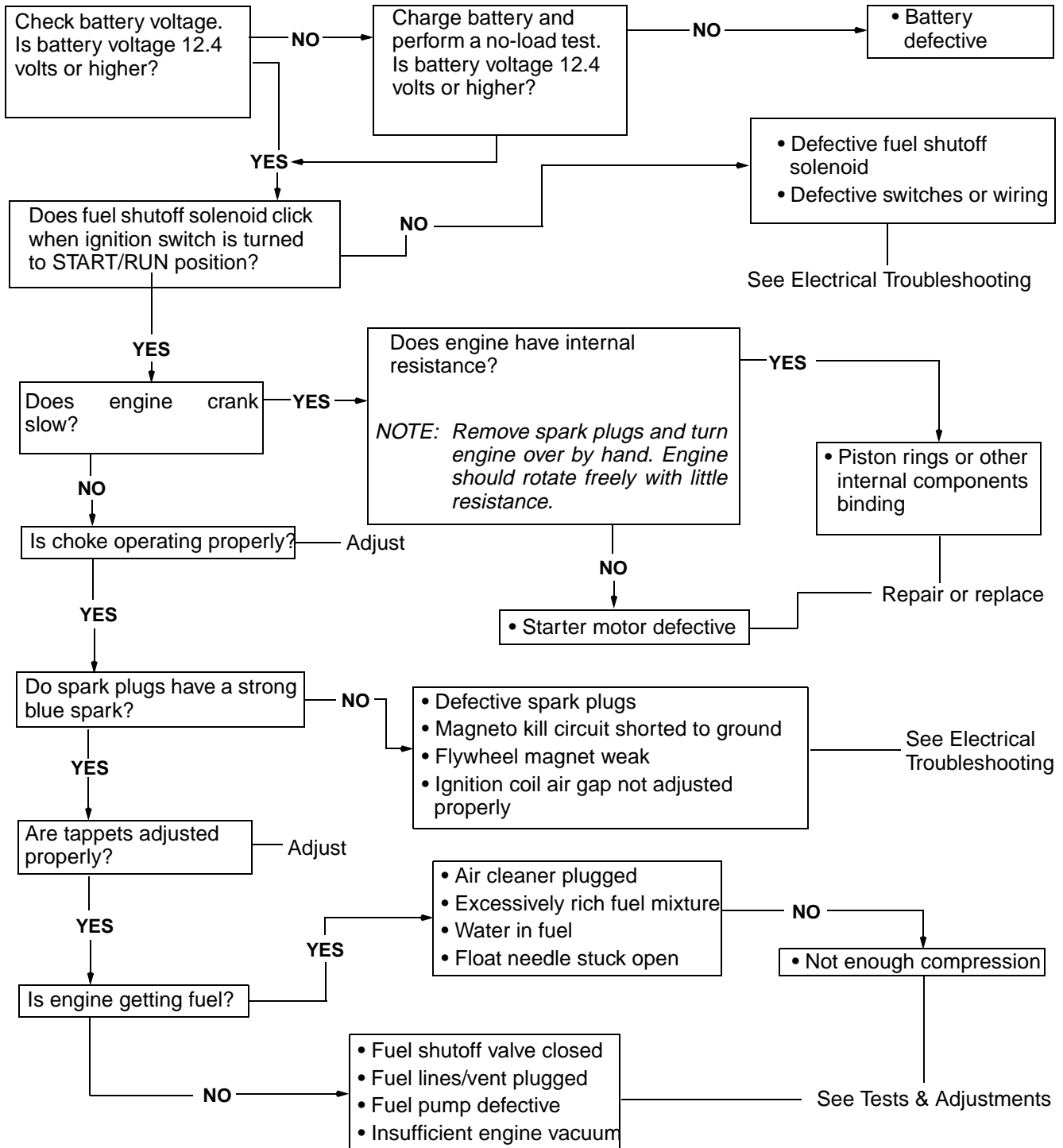

**Thank you very much
for your reading.**

Please Click Here

**Then Get More
Information.**